

TEC

TEC Electronic Cash Register

MA-186-100 SERIES

Owner's Manual

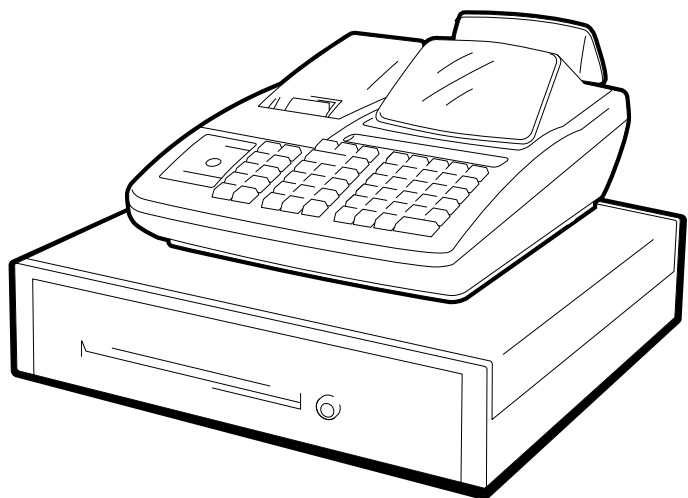

TOSHIBA TEC CORPORATION

NOTICE

This equipment has been tested and found to comply with the limits for a Class A digital device, pursuant to Part 15 of the FCC Rules. These limits are designed to provide reasonable protection against harmful interference when the equipment is operated in a commercial environment. This equipment generates, uses, and can radiate radio frequency energy and, if not installed and used in accordance with the instruction manual, may cause harmful interference to radio communications. Operation of this equipment in a residential area is likely to cause harmful interference in which case the user will be required to correct the interference at his own expense. Changes or modifications not expressly approved by manufacturer for compliance could void the user's authority to operate the equipment.

WARNING

"This Class A digital apparatus meets all requirements of the Canadian Interference-Causing Equipment Regulations."

"Cet appareil numérique de la classe A respecte toutes les exigences du Règlement sur le matériel brouilleur du Canada."

Safety Summary

Personal safety in handling or maintaining the equipment is extremely important. Warnings and Cautions necessary for safe handling are included in this manual. All warnings and cautions contained in this manual should be read and understood before handling or maintaining the equipment.

Do not attempt to effect repairs or modifications to this equipment. If a fault occurs that cannot be rectified using the procedures described in this manual, turn off the power, unplug the machine, then contact your authorized TOSHIBA TEC representative for assistance.

Meanings of Each Symbol



This symbol indicates warning items (including cautions). Specific warning contents are drawn inside the \triangle symbol. (The symbol on the left indicates a general caution.)



This symbol indicates prohibited actions (prohibited items). Specific prohibited contents are drawn inside or near the \circ symbol. (The symbol on the left indicates "no disassembling".)













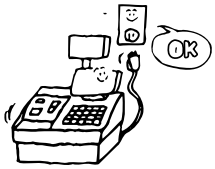

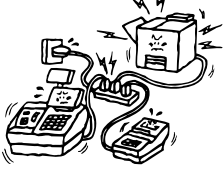





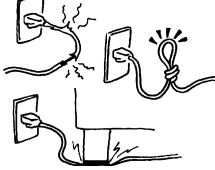

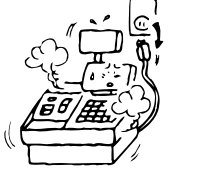

This symbol indicates actions which must be performed. Specific instructions are drawn inside or near the \bullet symbol. (The symbol on the left indicates "disconnect the power cord plug from the outlet".)

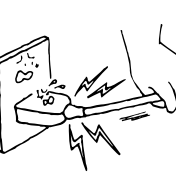

WARNING

This indicates that there is the risk of **death** or **serious injury** if the machines are improperly handled contrary to this indication.

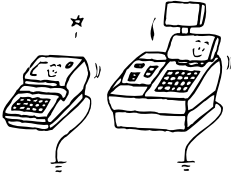
<p> Prohibited</p> <p></p> <p>■ Do not plug in or unplug the power cord plug with wet hands as this may cause electric shock.</p>	<p> Any other than the specified AC voltage is prohibited.</p> <p> Do not use voltages other than the voltage (AC) specified on the rating plate, as this may cause fire or electric shock.</p>
<p> Prohibited</p> <p></p> <p>■ If the machines share the same outlet with any other electrical appliances which consume large amounts of power, the voltage will fluctuate widely each time these appliances operate. Be sure to provide an exclusive outlet for the machine as this may cause the machines to malfunction.</p>	<p> Prohibited</p> <p> Do not place metal objects or water-filled containers such as flower vases, flower pots or mugs, etc. on top of the machines. If metal objects or spilled liquid enter the machines, this may cause fire or electric shock.</p>
<p> Prohibited</p> <p></p> <p>■ Do not insert or drop metal, flammable or other foreign objects into the machines through the ventilation slits, as this may cause fire or electric shock.</p>	<p> Prohibited</p> <p> Do not scratch, damage or modify the power cords. Also, do not place heavy objects on, pull on, or excessively bend the cords, as this may cause fire or electric shock.</p>
<p> Disconnect the plug.</p> <p></p> <p>■ If the machines are dropped or their cabinets damaged, first turn off the power switches and disconnect the power cord plugs from the outlet, and then contact your authorized TOSHIBA TEC representative for assistance. Continued use of the machine in that condition may cause fire or electric shock.</p>	<p> Disconnect the plug.</p> <p> Continued use of the machines in an abnormal condition such as when the machines are producing smoke or strange smells may cause fire or electric shock. In these cases, immediately turn off the power switches and disconnect the power cord plugs from the outlet. Then, contact your authorized TOSHIBA TEC representative for assistance.</p>

 <p>Disconnect the plug.</p>  <p>■ If foreign objects (metal fragments, water, liquids) enter the machines, first turn off the power switches and disconnect the power cord plugs from the outlet, and then contact your authorized TOSHIBA TEC representative for assistance. Continued use of the machine in that condition may cause fire or electric shock.</p>	 <p>Disconnect the plug.</p>  <p>■ When unplugging the power cords, be sure to hold and pull on the plug portion. Pulling on the cord portion may cut or expose the internal wires and cause fire or electric shock.</p>
 <p>Connect a grounding wire.</p>  <p>■ Ensure that the equipment is properly grounded. Extension cables should also be grounded. Fire or electric shock can occur on improperly grounded equipment.</p>	 <p>No disassembling.</p>  <p>■ Do not remove covers, repair or modify the machine by yourself. You may be injured by high voltage, very hot parts or sharp edges inside the machine. Unauthorized modification is prohibited.</p>



CAUTION This indicates that there is the risk of personal **Injury** or **damage** to objects if the machines are improperly handled contrary to this indication.

Precaution

The following precautions will help to ensure that this machine will continue to function correctly.

- Try to avoid locations that have the following adverse conditions:
 - * Temperatures out of the specification
 - * Direct sunlight
 - * High humidity
 - * Shared power socket
 - * Excessive vibration
 - * Dust/Gas
- Do not subject the machine to sudden shocks.
- Do not press the keys too hard. Keys will operate correctly if they are touched lightly.
- Clean the cover and keyboard, etc. by wiping with a dry cloth or a cloth soaked with detergent and wrung out thoroughly. Never use thinner or other volatile solvent for cleaning.
- At the end of the day, turn the power OFF, then clean and inspect the exterior of the machine.
- Try to avoid using this equipment on the same power supply as high voltage equipment or equipment likely to cause mains interference.
- USE ONLY TOSHIBA TEC SPECIFIED consumables.
- DO NOT STORE the consumables where they might be exposed to direct sunlight, high temperatures, high humidity, dust, or gas.
- When moving the machine, take hold of the drawer and lift the machine.
- Do not place heavy objects on top of the machines, as these items may become unbalanced and fall causing **injury**.
- Do not block the ventilation slits of the machines, as this will cause heat to build up inside the machines and may cause **fire**.
- Do not lean against the machine. It may fall on you and could cause **injury**.

Request Regarding Maintenance

- Utilize our maintenance services.

After purchasing the machines, contact your authorized TOSHIBA TEC representative for assistance once per year or so to have the inside of the machines cleaned. Otherwise, dust will build up inside the machines and may cause **fire** or **malfunction**. Cleaning is particularly effective before humid rainy seasons.

- Our maintenance service performs the periodic checks and other work required to maintain the quality and performance of the machines, preventing accidents beforehand.

For details, please consult your authorized TOSHIBA TEC representative for assistance.

- Using insecticides and other chemicals

Do not expose the machines to insecticides or other volatile solvents, as this will deteriorate the cabinet or other parts or cause the paint to peel.

TABLE OF CONTENTS

	Page
1. Introduction	1
2. Unpacking	2
3. Outline of Preparation Procedure Before Operating the ECR	3
4. Appearance and Nomenclature	5
5. Control Lock and Control Keys	6
Control Keys	6
Control Lock	6
6. Display	7
Operator's Display	7
Customer's Display	7
Numeric Display	8
Message Descriptors (Triangular Lamps)	8
7. Keyboard	9
Standard Keyboard Layout	9
Other Optional Keys:	9
8. Installing the Paper Roll	10
9. Time and Date Setting	13
Time Setting or Adjustment	13
Date Setting or Adjustment	14
Displaying the Time	15
Printing the Time and Date	15
10. Tax Table Setting	15
U.S. Tax Tables Setting (also applicable to PST in Canada)	15
GST Rate Setting (applicable to Canada only)	19
Non-taxable Limit Amount Setting (applicable to only certain areas in Canada)	20
Tax Calculation Test	21
11. Optional Key Setting	21
List of Keys	21
Key Installation Setting	23
Blank Keyboard Sketch (for your planning aid)	23
12. Daily Operation Flow	25
13. Training	26
14. Setting Preparation of Each Key and Transaction Entries	27
Receipt-issue/Non-issue Selection	27
Clearing Errors, or Clearing Wrong Declaration Key or Wrong Numeric Entries	28
No-sale (Exchange)	29
Received-on-Account Payment	30
Paid Out	31
Department Keys	31
PLU (Price-Look-Up) (PLU Key)	40
Listing Capacity Open	46
Percent Charge, Percent Discount	46
Dollar Discount	49
Item Correct (Last Line Voiding)	49
Void (Designated Line Voiding)	50
All Void (Transaction Cancel)	51
Returned Merchandise	51
Non-add Number Print	52
Subtotal Read	53
Taxable Total Read	53
Manual Tax Entry	54
Finalizing a Sale	54
Check Cashing (Cashing Non-cash Media)	55
Post-issue Receipt	55

Tax Status Modification	56
Tax Exemption	57
Print/Non-print Options on Sale Receipts	58
15. Read and Reset Reports	59
Programming Operations Relating to Reports	59
Taking Read and Reset Reports	61
16. System Option Setting	69
Address: 1	71
Address: 2	72
Address: 3	73
Address: 6	74
Address: 7	75
Address: 8	76
Address: 11	77
Address: 13	78
Address: 14	79
Address: 15	80
Address: 16	81
17. Cashier Signing Operation (optional function)	82
Programming Requirements	82
Cashier Sign ON & Sign OFF	82
Cashier Reports	83
18. Electronic Journal (E.J.) Print (optional function)	83
Programming Requirement	83
E.J.-Near-Full Warning in REG Mode	83
Reading of the Remaining Lines of E.J. Memory	84
Electronic Journal Report	84
19. Program Data Verification	86
Operating Procedure	86
20. Paper Roll Replacement and Other Maintenance	90
Replacing the Paper Roll	90
Replacing the Ink Ribbon	93
Replenishing Ink to the Store Name Stamp	95
Manual Drawer Release and Lock	96
Removing the Drawer	97
Battery Exchange	97
Changing the Layout of the Money Case	98
Media Slot	99
21. In Case of the Power Failure	100
22. Troubleshooting	100
23. Status Clear and Memory Clear Operations	104
Status Clear	104
Sales Memory Clear	105
All Memory Clear	106
24. Specifications	107
Stamp Order	109

CAUTION:

1. *This manual may not be copied in whole or in part without prior written permission of TOSHIBA TEC.*
2. *The contents of this manual may be changed without notification.*
3. *Please refer to your local Authorized Service representative with regard to any queries you may have in this manual.*

1. Introduction

Thank you for choosing the TEC electronic cash register MA-186-100 series. This owner's manual provides a description of the functions and handling of this register and should be read carefully to ensure optimum performance. Since every consideration has been given to safety and reliability, there is no danger of damaging the machine by incorrect operation.

Please refer to this manual whenever you have any questions concerning the machine. This machine has been manufactured under strict quality control and should give you full satisfaction. However, if the machine is damaged during transit, or there are any unclear points in this manual:

For supplies, service or assistance call:

Please have the following information available when you call:

Product Name:	TEC Electronic Cash Register
Model:	MA-186-100
Serial Number:	_____
Place Purchased:	_____
Date of Purchase:	_____

If for any reason this product is to be returned to the store where purchased, it must be packed in the original carton.

- The specifications described in this manual may be modified by TOSHIBA TEC, if necessary.
- Be sure to keep this manual for future reference.

2. Unpacking

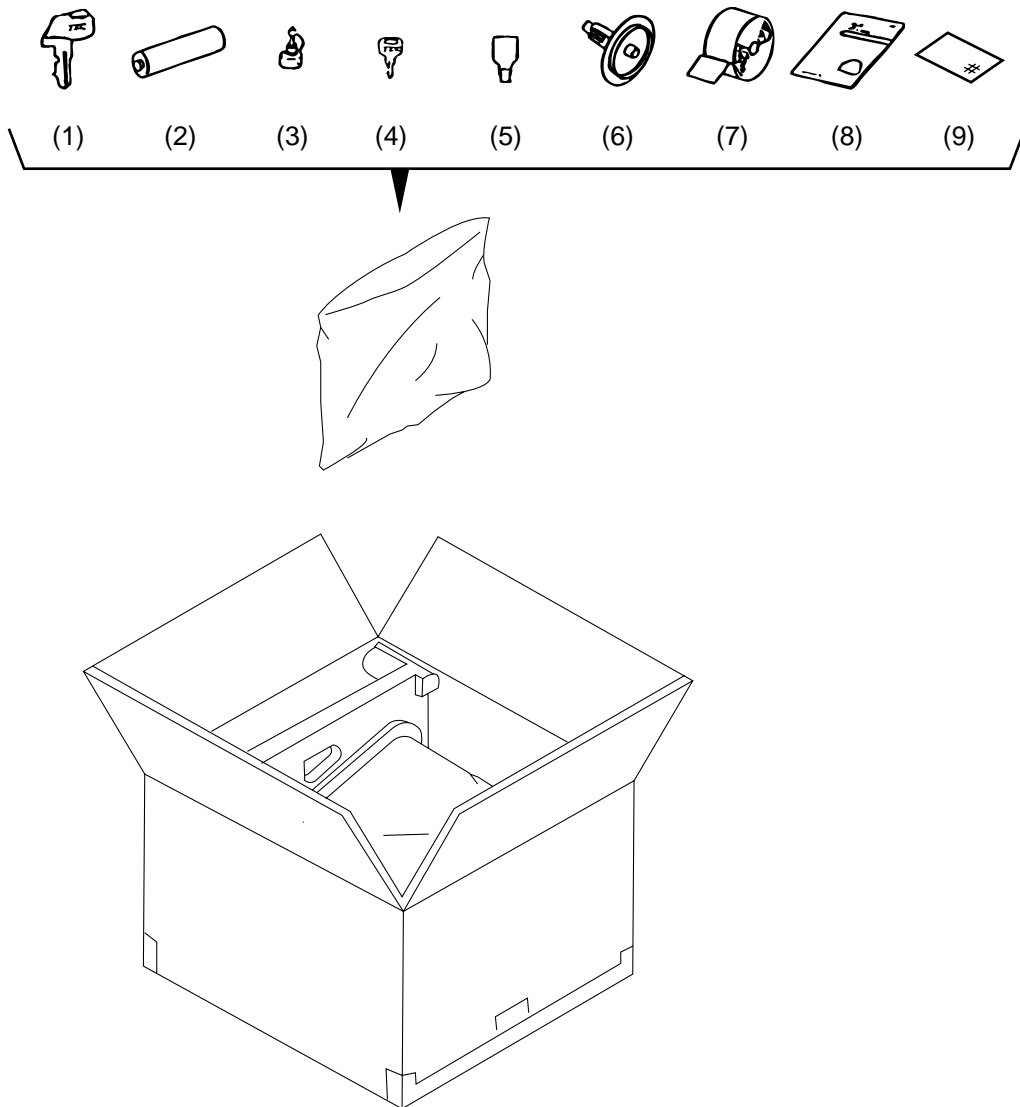

- | | |
|--|---------------------------------------|
| (1) Control Key
(REG Key, MA Key, S Key: 2 pcs. respectively) | (5) Printer Cover Key (2 pcs.) |
| (2) Dry Battery (SUM-3 1.5V) (3 pcs.) | (6) Paper Roll 58 mm x ø50 mm (1 pc.) |
| (3) Stamp Ink (1 pc.) | (7) Journal Take-up Reel (1 pc.) |
| (4) Drawer Key (2 pcs.) | (8) Owner's Manual (1 pc.) |
| | (9) Warranty Registration (1 pc.) |

3. Outline of Preparation Procedure Before Operating the ECR

This chapter shows the outline of set-up procedure of the ECR before actually starting the ECR operation.

- 1 Remove the cash register from the carton, referring to **Chapter 2. Unpacking** on page 2. And take out all the parts and accessories.

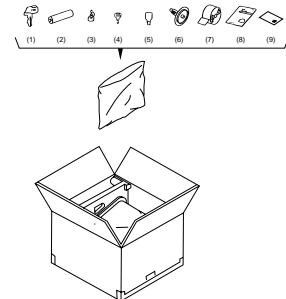

- 2 Remove the tapes and seals for holding parts or protecting the register surfaces.

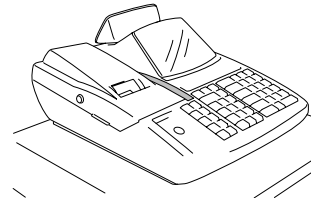

- 3 Plug the power cord of the register into a wall outlet. Make sure that the outlet voltage matches that of the power required for the register.
WARNING: *Be sure to plug in the power cord first, then insert the batteries.*

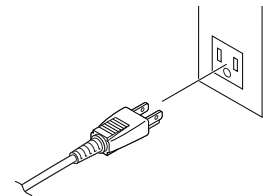

- 4 Detach the Printer Cover and the Battery Cover, then insert the batteries (3 pieces).
WARNING: *Be certain to insert the batteries enclosed in the package. If they are not inserted and the power is turned OFF (including a power failure occurrence), the sales data and the programmed data will be cleared.*

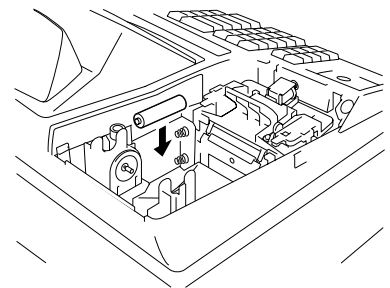

- 5 Insert the **REG** key into the Control Lock.

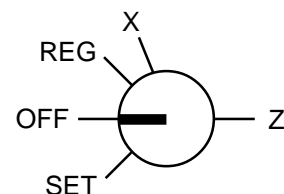

6 Turn the Control Lock to the **REG** position.

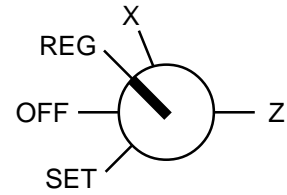

7 Install the paper roll (referring to Chapter “8. Installing the Paper Roll” on page 10).

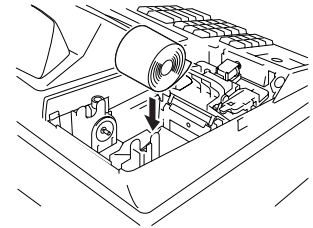

8 If any optional keys are installed or relocated on the keyboard, the optional key setting programming must be performed first before any other programming. Refer to Chapter “11. Optional Key Setting” on page 21.

9 Set the time and date correctly, referring to Chapter “9. Time and Date Setting” on page 13.

10 Set the tax tables, referring to the Chapter “10. Tax Table Setting” on page 15.

11 Perform programming of the register, such as Departments and PLUs, according to the requirement of the market and your store (refer to **Chapter 14** and thereafter).

4. Appearance and Nomenclature

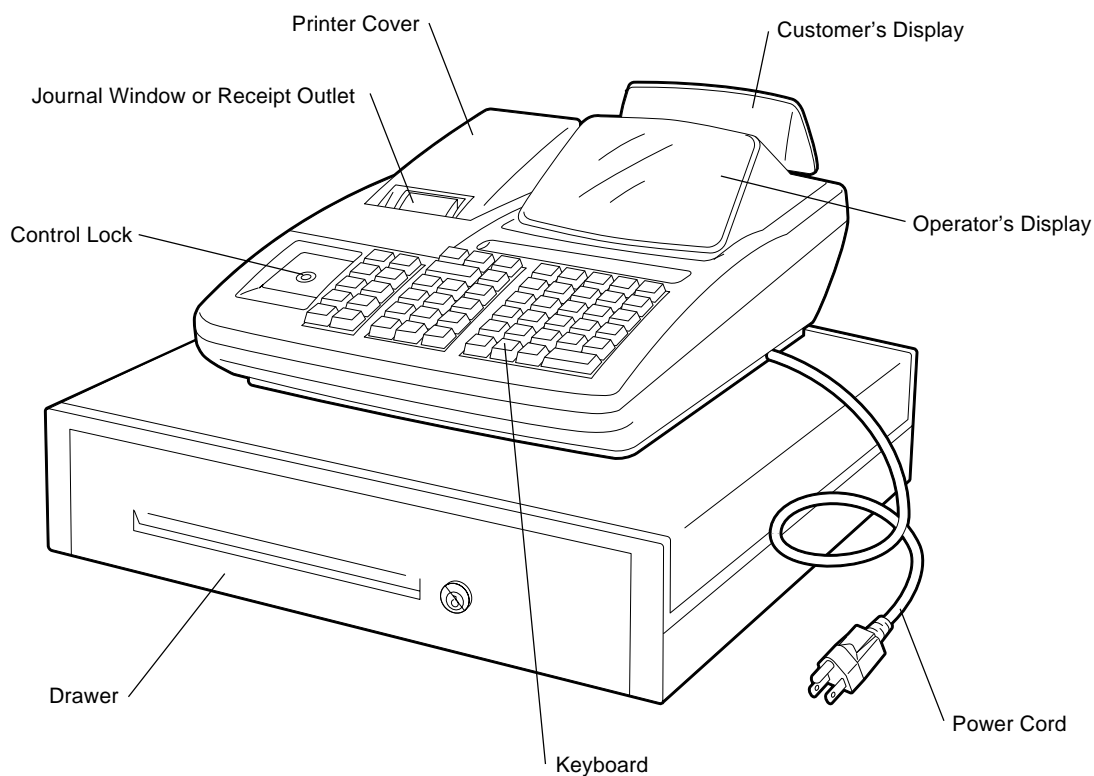

Operator's Display

Used by the operator to confirm the entry contents and the status of the register. (page 7)

Customer's Display

Provided for the customer to see the amount entered for each item and sale total. (page 7)

Journal Window/Receipt Outlet

The operator can see which items have already been entered through this window with the Journal-format Option.

The receipt for the finalized sale is issued with the Receipt-format Option.

Printer Cover

The cover for the Receipt/Journal printer.

Control Lock

It selects the type of register operations. (page 6)

Keyboard

Used to enter sale items. (page 9)

Drawer

Cash and other media are kept here. It automatically opens on finalizing a sale.

5. Control Lock and Control Keys

Control Keys

There are three types of Control keys: the **REG** (registration) key, the **MA** (manager) key, and the **S** (service) key.

REG Key:



The REG key is used by the cashier or clerk who operates ordinary transaction entries. This key can access the positions of **OFF** and **REG** of the Control Lock.

MA Key:

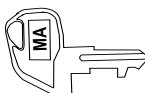

The MA key is used by the store manager or owner who will daily supervise the collection of money and printout of transactions recorded by the register. This key is also used when programming the register. This key can access the positions of **SET**, **OFF**, **REG**, **X**, and **Z**.

S Key:



The S key is used by the owner. This key can access any position including **BLIND** of the Control Lock. To prevent programmed data and sales data from being changed or cleared by mistake, use the REG or MA keys for transaction entries or report taking purposes.

Control Lock

The Control Lock has six effective positions for different modes of operation, which are accessed by the appropriate Control Keys.

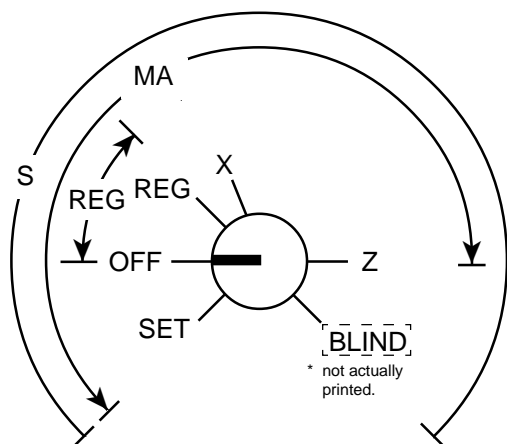

(position)	(function)
SET	The register allows programming and training operations.
OFF	Nothing appears on the display in this position. However, the power is being supplied to the register.
REG	Transaction entries are carried out in this mode. Displays the current time while no entries are under way.
X	The sale totals in memory can be read (X reports) and the programmed data can be verified in this position.
Z	All the resettable totals and their respective counters in memory will be read and reset in this position (Z reports).
BLIND	The register allows special programming operations and memory clear operations.

The keys may be inserted or pulled out at the "OFF" or "REG" position.

6. Display

The Operator's Display (front display) is located at the top of the register just above the keyboard. The Customer's Display may be used only as a rear display if left in the retracted position or it can be positioned for viewing at other angles by pulling it upward and turning it to the desired position. The display has two types of display portions—numeric display and message descriptors (triangular lamps).

Operator's Display

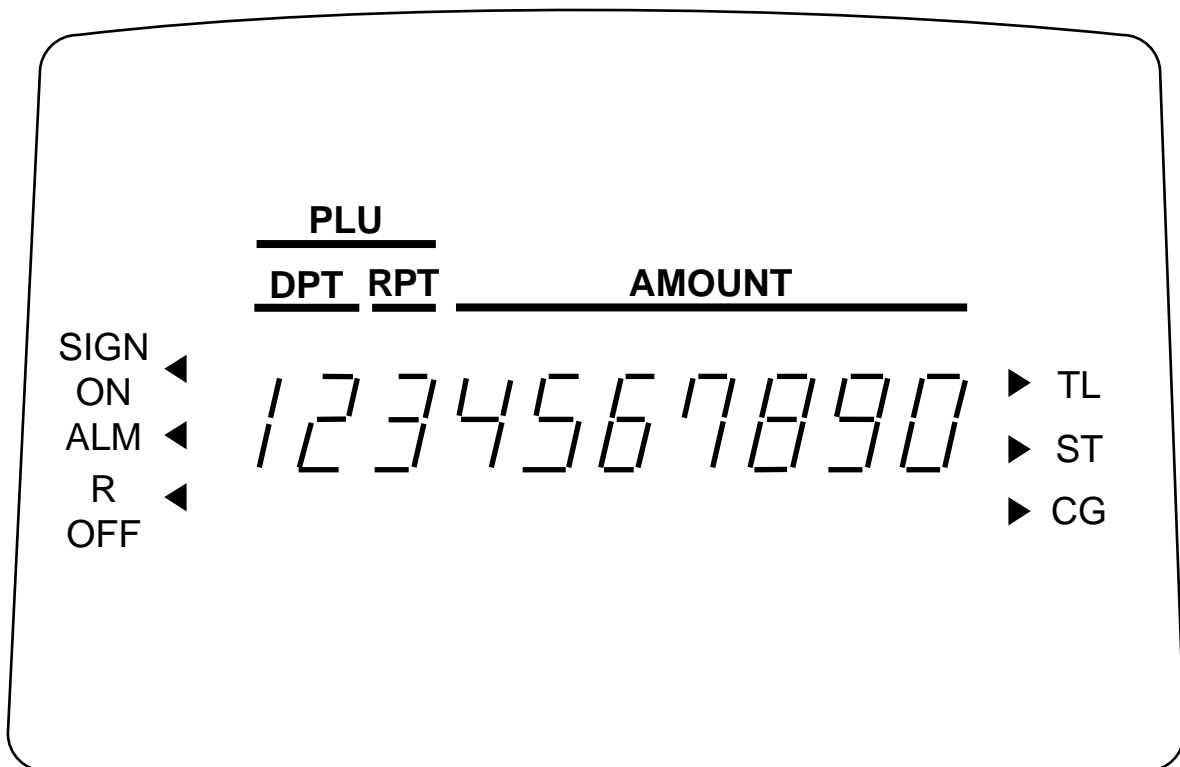

Customer's Display

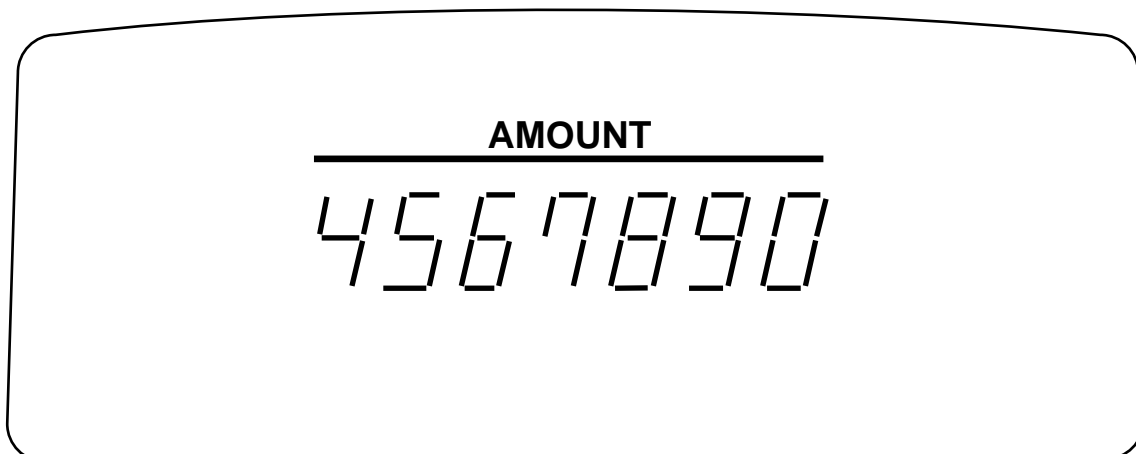

Numeric Display

- AMOUNT** (8 digits for total display, 7 digits for entries):
Displays the numeric data, such as amount, quantity, etc. When the obtained total or subtotal amount is 8-digit, the **RPT** digit is also used for the amount display. When no entries are under way and the Control Lock is in the **REG** position, the current time is displayed.
- DPT** (2 digits):
Displays the code which represents each Department key. It stays lit when repeating the same department entry.
- RPT** (1 digit):
Displays the repeat count of the same item. The count is indicated from the second entry on, and only the last digit will be displayed even if the count exceeds nine.
- PLU** (3 digits of the DPT and RPT are used for this purpose):
Displays the PLU code when any PLU is entered. It goes out when repeating the same PLU entry, then only the **RPT** digit will be displayed for the repeat entry count.

Message Descriptors (Triangular Lamps)

- SIGN ON** :
Illuminates when a cashier has signed ON if the cashier signing method is selected (optional function).
- ALM** :
Illuminates with the alarm buzzer to indicate that the last operation or numeric entry was an error. To clear the error condition, depress the **[C]** key.
- R OFF** :
Illuminates when the Receipt-OFF mode is declared by the **[LOG/RECEIPT]** key. In this condition, no receipts will be issued for a sale to be entered. To extinguish this lamp (i. e., to change into Receipt-ON mode for issuing receipts), simply depress the **[LOG/RECEIPT]** key again.
- TL** :
Illuminates with the total amount displayed when a sale is finalized without any amount tendered.
- ST** :
Illuminates with the subtotal amount displayed when the **[ST]** or **[TXBL TL]** key is depressed.
- CG** :
When an amount tendering operation has been performed, this lamp illuminates with the amount of change due displayed.

7. Keyboard

The following is the standard keyboard layout, which was initially set at the factory. This register is designed to be capable of programming most of the keys at desired locations or adding some optional keys in place of the current keys. If you are in need of changing the locations or adding keys, see Chapter “11. **Optional Key Setting**” on page 21.

Standard Keyboard Layout

		Department Keys 1 to 40																
<table border="1"> <tr> <td># / CID</td> <td>FEED</td> </tr> <tr> <td>R / A</td> <td>PO</td> </tr> <tr> <td>TX/M</td> <td>LC OPEN</td> </tr> <tr> <td>% -</td> <td>PLU</td> </tr> <tr> <td>ITEM CORR</td> <td>AMT</td> </tr> </table>	# / CID	FEED	R / A	PO	TX/M	LC OPEN	% -	PLU	ITEM CORR	AMT	VOID	ALL VOID	NS	21 1	26 6	31 11	36 16	DPT SHIFT
	# / CID	FEED																
	R / A	PO																
	TX/M	LC OPEN																
	% -	PLU																
	ITEM CORR	AMT																
C	@ / FOR	22 2	27 7	32 12	37 17	REPEAT												
7	8	9	23 3	28 8	33 13	38 18	DOLL DISC											
4	5	6	24 4	29 9	34 14	39 19	RTN MDSE											
1	2	3	25 5	30 10	35 15	40 20	ST											
0	00	.	Chg	CHK TND	TXBL TL	AT TL												

Other Optional Keys:

- | | | | | | | | | | |
|---|------|----|----------------|------------------|---|-------|-----|----|-------|
| <ul style="list-style-type: none"> • <table border="1" style="display: inline-table; vertical-align: middle;"> <tr><td>#/NS</td></tr> </table> (Non-add Number Print / No-sale Key) • <table border="1" style="display: inline-table; vertical-align: middle;"> <tr><td>%+</td></tr> </table> (Percent Charge Key) • <table border="1" style="display: inline-table; vertical-align: middle;"> <tr><td>LOG
RECEIPT</td></tr> </table> (Log/Receipt Key) • <table border="1" style="display: inline-table; vertical-align: middle;"> <tr><td>RECEIPT
ISSUE</td></tr> </table> (Post-receipt Key) | #/NS | %+ | LOG
RECEIPT | RECEIPT
ISSUE | <ul style="list-style-type: none"> • <table border="1" style="display: inline-table; vertical-align: middle;"> <tr><td>TX2/M</td></tr> </table> (Tax 2 Modifier Key) • <table border="1" style="display: inline-table; vertical-align: middle;"> <tr><td>TAX</td></tr> </table> (Manual Tax Key) • <table border="1" style="display: inline-table; vertical-align: middle;"> <tr><td>EX</td></tr> </table> (Tax Exempt Key) • <table border="1" style="display: inline-table; vertical-align: middle;"> <tr><td>GST/M</td></tr> </table> (GST Modifier Key; for Canada) | TX2/M | TAX | EX | GST/M |
| #/NS | | | | | | | | | |
| %+ | | | | | | | | | |
| LOG
RECEIPT | | | | | | | | | |
| RECEIPT
ISSUE | | | | | | | | | |
| TX2/M | | | | | | | | | |
| TAX | | | | | | | | | |
| EX | | | | | | | | | |
| GST/M | | | | | | | | | |

8. Installing the Paper Roll

The printer may be used for journal-format print (standard status) or receipt-format print (optional status). For reversing the status, refer to Chapter "16. System Option Setting", Address 2-Bit 7" on page 72.

WARNING!

Care must be taken not to injure yourself with the paper cutter.

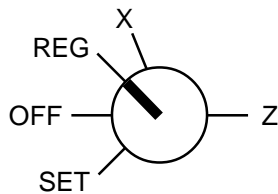

1

Turn the Control Lock to the REG position using a Control Key.

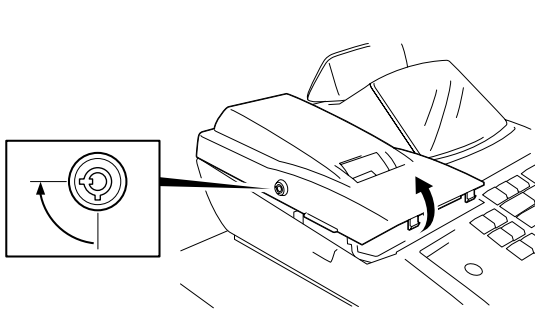

2

To remove the Printer Cover, insert the Printer Cover Key to the Printer Cover Lock, and then turn it 90° clockwise.

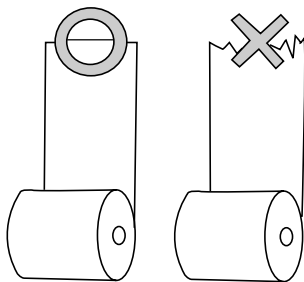

3

Cut the paper end to make it sharp.

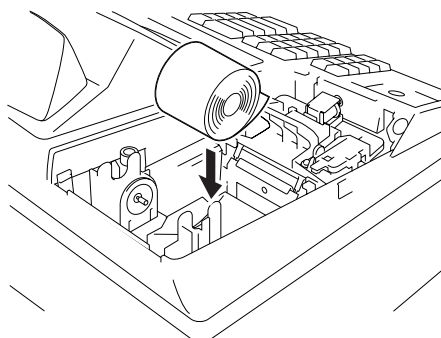

4

Place the paper roll into the paper pocket. Place the paper roll as shown below.

Correct

Incorrect

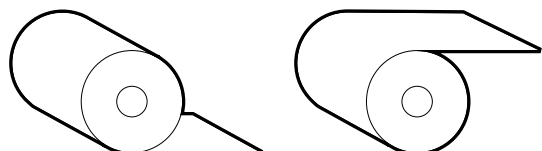

Note on placing the 2-ply paper:

Correct

When using the 2-ply paper, place it into the paper pocket as shown below.

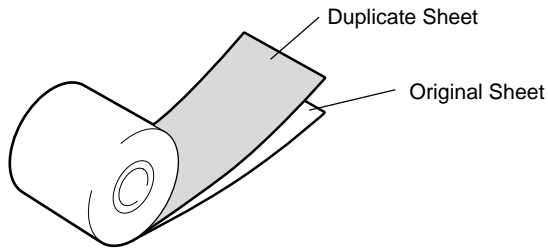

Incorrect

If the 2-ply paper has been placed as shown below, the printing contents are not copied. In this case, re-place the 2-ply paper as shown above.

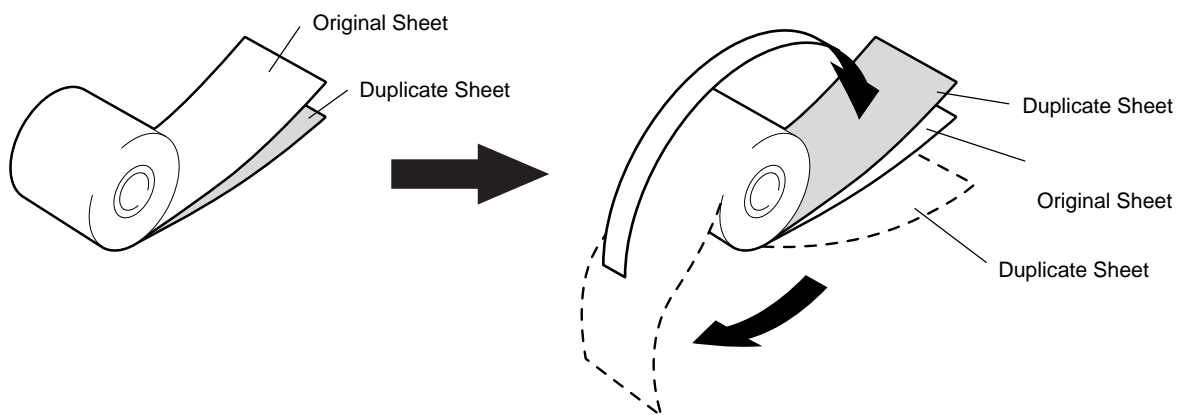

* Place the duplicate sheet inside the original sheet.

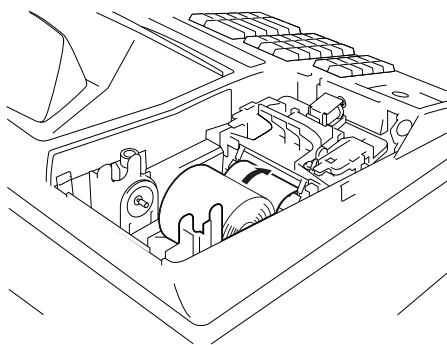

5

Insert the paper end into the paper inlet located on the rear side of the printer.

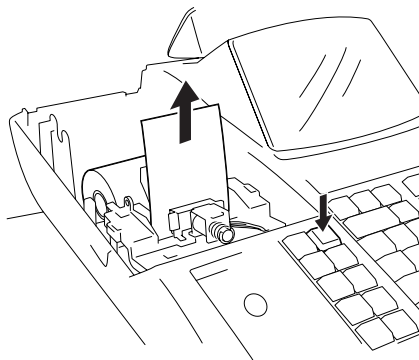

6

Press the **[FEED]** key on the keyboard until the paper end comes out of the outlet.

7

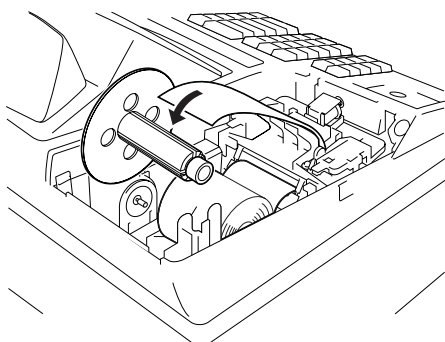

If used for journal, insert the paper end into the slit on the Take-up Reel and wind it around the reel two or three times, set the reel to the holder, and press the **[FEED]** key for a while to tense the paper.

If used for receipt, do not wind the paper end around the Journal Take-up Reel.

* When the 2-ply paper is used, wind the duplicate sheet around the Journal Take-up Reel in the same manner as described in "If used for journal,". At this time, do not wind the original sheet around the Journal Take-up Reel.

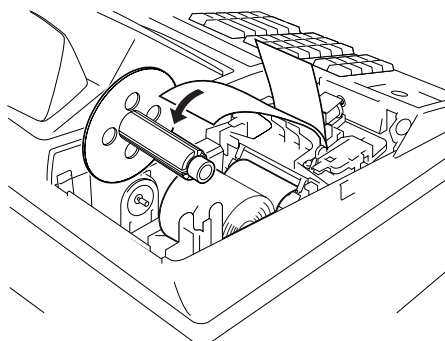

8

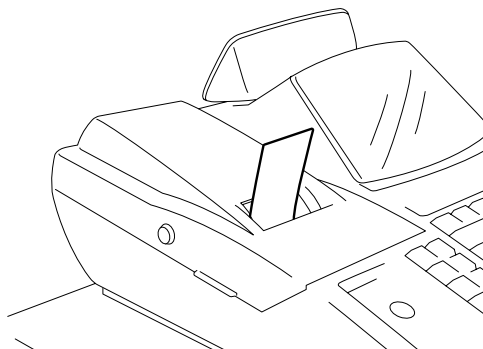

If used for journal, simply attach the Printer Cover. The Receipt Outlet is used as a Journal Window.

If used for receipt, attach the Printer Cover with the paper end coming out of the Receipt Outlet located on the Printer Cover.

* When the 2-ply paper is used, load the original sheet as a receipt, and duplicate sheet as a journal.

9. Time and Date Setting

Time Setting or Adjustment

The register has a clock function. Once the time is set, the time is kept even when the power is turned off. The 24-hour system (the military time) is used for time setting, display, and printing. Time setting is allowed any time outside a sale.

Condition: Any time outside a sale; refer to “NOTE on Condition” on page 15.

Setting Procedure:

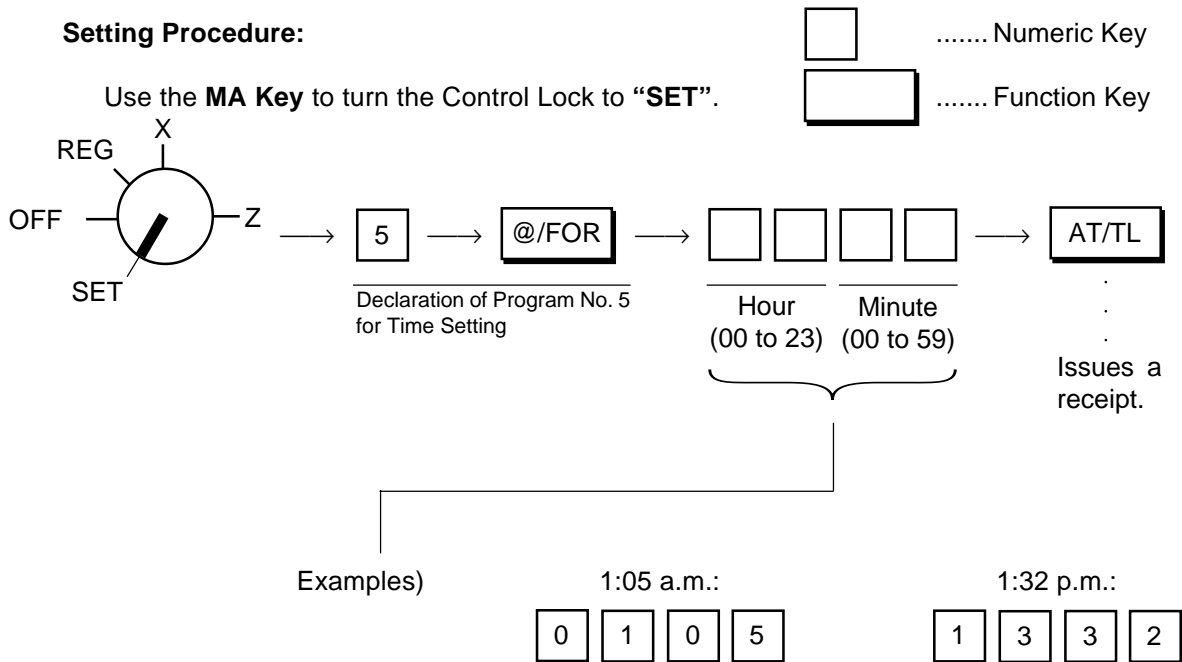

Receipt Print Format:

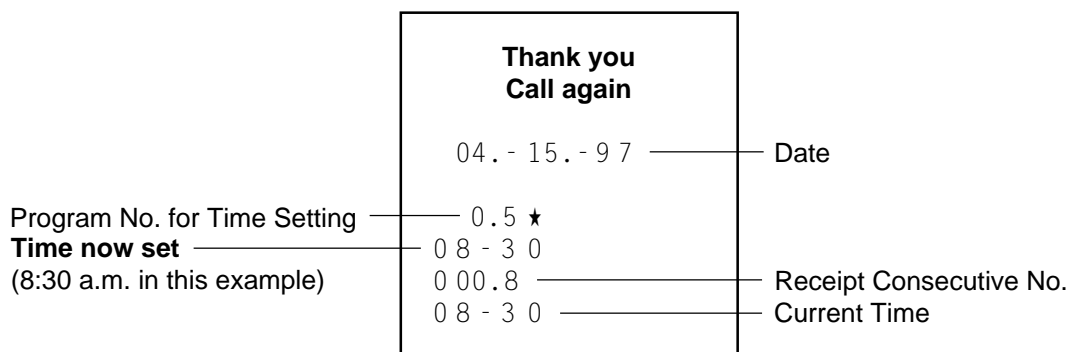

Date Setting or Adjustment

The register has a calendar function. Once the date and time are correctly set, the day automatically advances at midnight even when the power is turned off. The extra day of a leap year is also computed automatically.

Condition: Any time outside a sale; refer to “**NOTE on Condition**” on page 15.

Setting Procedure:

Use the **MA Key** to turn the Control Lock to “**SET**”.

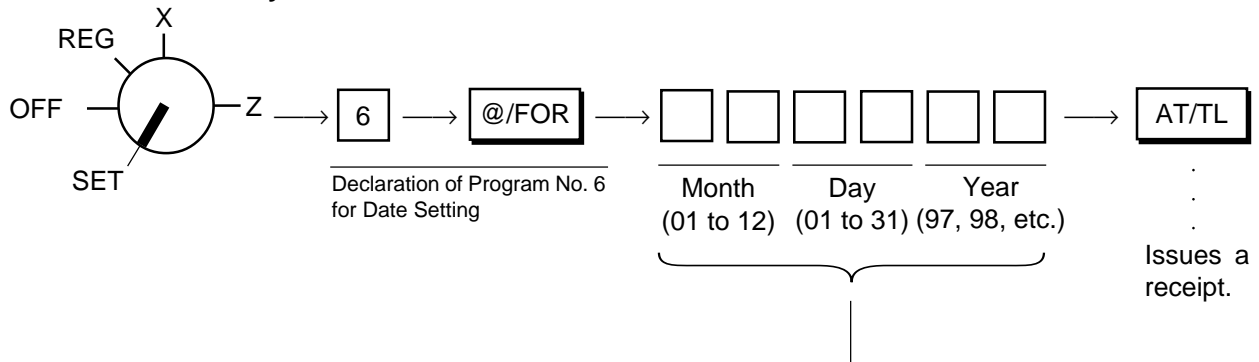

NOTE: The date set/print order is Month-Day-Year. If you want to change the order into Day-Month-Year or Year-Month-Day, see Chapter “16. System Option Setting”, Address 16 - Bits 7 and 8 on page 81.

Examples) To set 28 May, 1997:

0	5	2	8	9	7	Month-Day-Year order
Month			Day		Year	
2	8	0	5	9	7	Day-Month-Year order
Day		Month		Year		
9	7	0	5	2	8	Year-Month-Day order
Year		Month		Day		

Receipt Print Format:

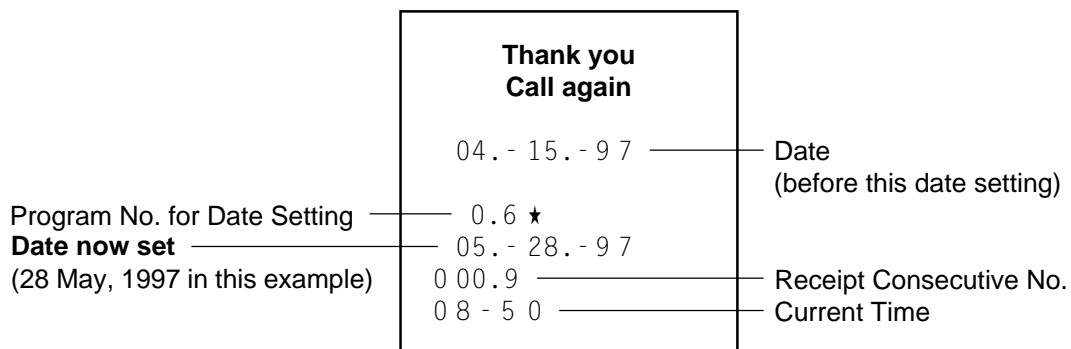

Displaying the Time

The current time is displayed in the “AMOUNT” area when the Control Lock is turned to **REG** from any other position. When the Control Lock position is changed or any entry operation starts, the displayed time disappears.

Time Display Format:
(Example: 1:45 p.m.)

13-45

Printing the Time and Date

The current time is printed on every receipt, as the bottom line (*refer to the **Receipt Print Format** on the preceding page*). The time can be programmed to non-print, if necessary, by a System Option selection (*refer to Chapter “16. System Option Setting”, Address 1 - Bit 1 on page 71*).

The date is printed on every receipt, as the top line below the Store Name Stamp print (*refer to the **Receipt Print Format** on the preceding page*). The quickest way to verify the date print with the Control Lock in **REG** position is to issue a receipt of any transaction (for example, a No-sale receipt).

10. Tax Table Setting

For details about the actual tax table, contact to the location where the register was purchased.

U.S. Tax Tables Setting (also applicable to PST in Canada)

There are three ways to set state and local tax tables. Select one that suits the tax table required to be set.

Condition: After Daily Financial Reset

NOTE on “Condition”:

Unless the register satisfies this condition, the programming operations will not be allowed. “After ... Reset” means that the designated reset report must be taken before entering the programming (setting) operation. An error will result if the operation is attempted without taking the report.

However, it does not necessarily mean “immediately after ...” When the designated reset report has already been taken and then some operations are performed in the “X”, “Z”, or “SET” mode, the condition “After ... Reset” is still satisfied and the programming operation is still allowed.

On the contrary, when the designated reset report has been taken but then some sales data relating to that report’s output data are entered in the “REG” mode, the programming operation will no longer be allowed and the same reset report must be taken again.

Thus the condition “After ... Reset” indicates that all the sales data relating to the report data must be zero (except non-resettable memory data). Because of this “Condition” requirement, the report data will be protected from any inconsistencies of sales data entered in the period from a resetting of the report to another resetting of the same report next time. When no condition is specified to a programming (setting) operation, it means that the operation is allowed any time outside a sale but the cashier must be signed off if the Cashier Signing Method is selected.

Setting Procedure:

Use the **MA Key** to turn the Control Lock to “**SET**”.

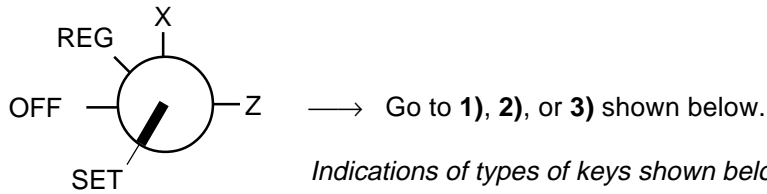

Indications of types of keys shown below:

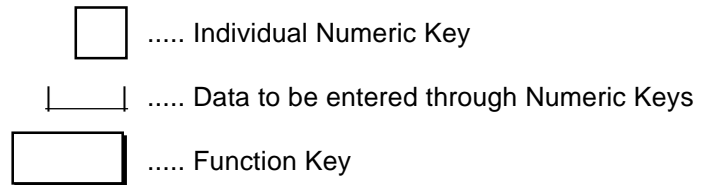

1) Tax 1; Full Breaks (Non-cyclic Breaks + Cyclic Breaks)

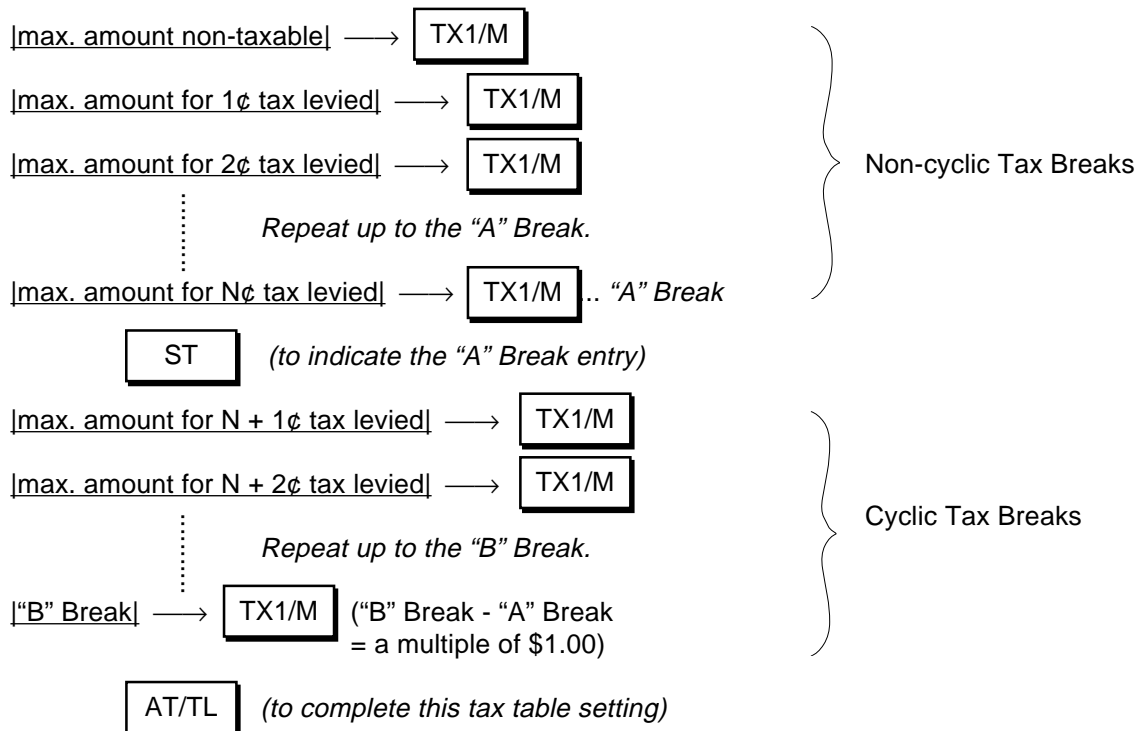

NOTE: Each amount (break) entry may be a maximum of 4-digit value (9999¢).

2) Tax 1; “A” Break and % Rate Combination (Non-cyclic Breaks + % Rate)

First, set all the non-cyclic breaks up to the “A” Break entry and the **[ST]** key depression shown in the above case of “**1) Tax 1 Full Breaks**”.

↓

[Tax Rate applied when exceeding the “A” Break amount]
(Max. 6 digits up to 99.9999%. Use the **[.]** key for a decimal value. Examples: To set 5%, enter 5. To set 5.26%, enter 5 → **[.]** → 2 → 6. The fraction of the amount resulting from this % rate calculation will be rounded off.)

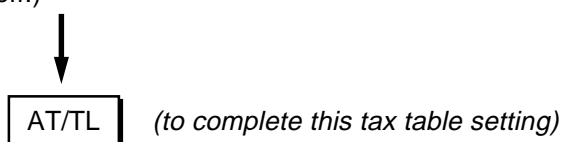

3) Tax 1; % Rate Only

→ (to indicate that no breaks are entered)

[Tax Rate applied to any amount] →

(The description for the Tax Rate in the above case **2**) is also applied to this case.)

- NOTES:**
1. In a single-tax area, the **[TX1/M]** key may be labeled as **[TX/M]** key.
 2. For Tax 2 table setting in a multi-tax area, follow the same procedure in **1), 2),** or **3)** above, using the **[TX2/M]** key instead of **[TX1/M]**. To install the **[TX2/M]** key on the keyboard, refer to Chapter **"11. Optional Key Setting"** on page 21.
 3. If two tax tables are to be set, the Tax 1 table must be set first. The Tax 1 table setting will automatically reset the old Tax 1 and Tax 2 tables.
 4. A maximum of 64 breaks may be entered for Tax 1 and Tax 2 tables altogether.

Setting Examples:

ex. 1) Tax 1; Full Breaks

Tax Table		Key Operation	
Amount Range	Tax Levied	Control Lock: SET	
\$0.00 to \$0.10	0¢	<input type="text" value="1"/> <input type="text" value="0"/>	<input type="text" value="TX1/M"/>
\$0.11 to \$0.22	1¢	<input type="text" value="2"/> <input type="text" value="2"/>	<input type="text" value="TX1/M"/>
\$0.23 to \$0.39	2¢	<input type="text" value="3"/> <input type="text" value="9"/>	<input type="text" value="TX1/M"/>
\$0.40 to \$0.56	3¢	<input type="text" value="5"/> <input type="text" value="6"/>	<input type="text" value="TX1/M"/>
\$0.57 to \$0.73	4¢	<input type="text" value="7"/> <input type="text" value="3"/>	<input type="text" value="TX1/M"/>
\$0.74 to \$0.90	5¢	<input type="text" value="9"/> <input type="text" value="0"/>	<input type="text" value="TX1/M"/>
\$0.91 to \$1.08	6¢	<input type="text" value="1"/> <input type="text" value="0"/> <input type="text" value="8"/>	<input type="text" value="TX1/M"/>
... "A" Break		<input type="text" value="ST"/>	
\$1.09 to \$1.24	7¢	<input type="text" value="1"/> <input type="text" value="2"/> <input type="text" value="4"/>	
\$1.25 to \$1.41	8¢	<input type="text" value="1"/> <input type="text" value="4"/> <input type="text" value="1"/>	<input type="text" value="TX1/M"/>
\$1.42 to \$1.58	9¢	<input type="text" value="1"/> <input type="text" value="5"/> <input type="text" value="8"/>	<input type="text" value="TX1/M"/>
\$1.59 to \$1.74	10¢	<input type="text" value="1"/> <input type="text" value="7"/> <input type="text" value="4"/>	<input type="text" value="TX1/M"/>
\$1.75 to \$1.91	11¢	<input type="text" value="1"/> <input type="text" value="9"/> <input type="text" value="1"/>	<input type="text" value="TX1/M"/>
\$1.92 to \$2.08	12¢	<input type="text" value="2"/> <input type="text" value="0"/> <input type="text" value="8"/>	<input type="text" value="TX1/M"/>
... "B" Break		<input type="text" value="AT/TL"/>	

**Thank you
Call again**

05. - 28. - 97

0.0 ★

0 0	★0.10				
0 1	★0.22				
0 2	★0.39				
0 3	★0.56				
0 4	★0.73				
0 5	★0.90				
0 6	★1.08				
	★1.08				TX1
0 7	★1.24				
0 8	★1.41				
0 9	★1.58				
1 0	★1.74				
1 1	★1.91				
1 2	★2.08				
	★2.08				TL
0 0	1.6				
0 8	- 5 4				

ex. 2) Tax 1; "A" Break and % Rate Combination

Tax Table		Key Operation	
<u>Amount Range</u>	<u>Tax Levied</u>	Control Lock: SET	
\$0.00 to \$0.10	0¢	[9]	[TX1/M]
\$0.00 to \$0.09	0¢	[2][9]	[TX1/M]
\$0.10 to \$0.29	1¢	[5][9]	[TX1/M]
\$0.30 to \$0.59	2¢	[8][4]	[TX1/M]
\$0.60 to \$0.84	3¢	[1][1][2]	[TX1/M]
\$0.85 to \$1.12	4¢	[ST]	
... "A" Break		[5]	[AT/TL]

5% is applied to any amount exceeding the "A" Break.

**Thank you
Call again**

05.- 28.- 97

0.0 ★

0 0 ★0.09 TX 1
0 1 ★0.29
0 2 ★0.59
0 3 ★0.84
0 4 ★1.12
★1.12 ST %

5.
0 01.7
0 8 - 5 4

ex. 3) Tax 1; % Rate only

Tax Table	Key Operation
10% is applied to any amount.	Control Lock: SET
	[0] [TX1/M]
	[ST]
	[1][0] [AT/TL]

**Thank you
Call again**

05.- 28.- 97

0.0 ★

0 0 ★0.00 TX 1
★0.00 ST %

10.
0 01.8
0 8 - 5 4

GST Rate Setting (applicable to Canada only)

Please note the following before operating the GST rate setting. The following preparations are required:

- 1) Select the "GST Active" status in Chapter "16. System Option Setting", Address 14-Bit 1 on page 79 (some other options can also be selected relating to GST in the same Address).
- 2) Install the [GST/M] (GST Modifier) key on the keyboard (in place of unnecessary key) referring to Chapter "11. Optional Key Setting" on page 21.

Condition: After Daily Financial Reset; refer to "NOTE on Condition" on page 20.

Setting Procedure:

Use the **MA Key** to turn the Control Lock to "SET".

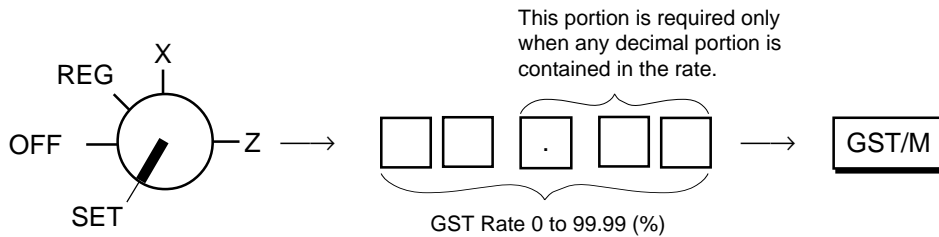

Examples)

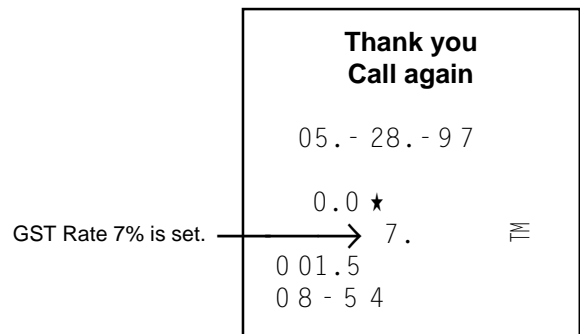
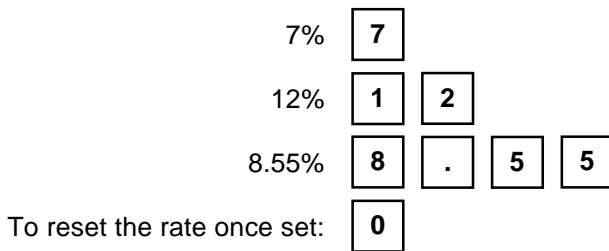

Non-taxable Limit Amount Setting (applicable to only certain areas in Canada)

This non-taxable amount limit must be set only in certain areas in Canada.

Condition: After Daily Financial Reset; refer to “**NOTE on Condition**” on page 15.

Setting Procedure:

Use the **MA Key** to turn the Control Lock to “**SET**”.

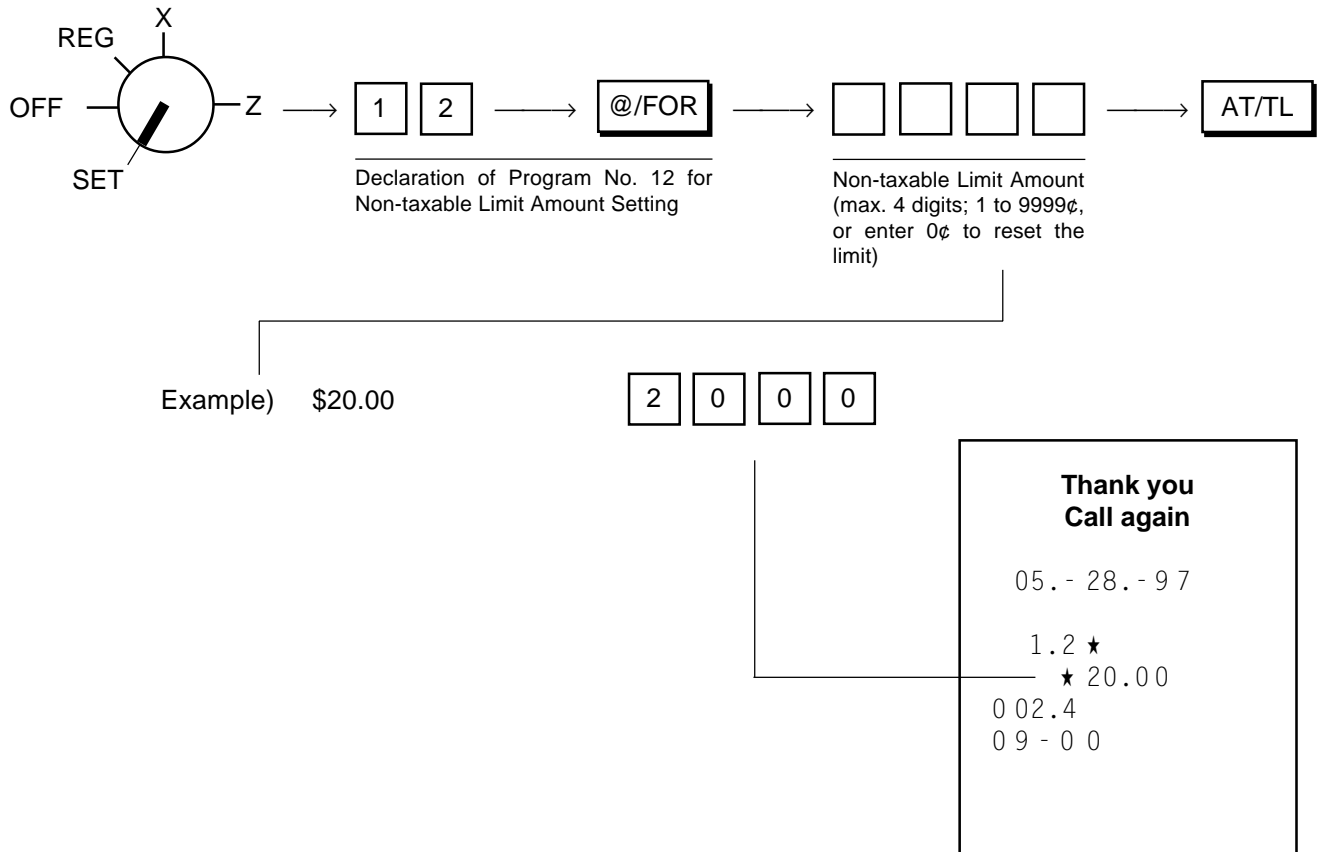

- NOTES:**
1. *When the sum of the sale portion subject to Tax (PST) 1 and the sale portion subject to Tax (PST) 2 exceeds the Non-taxable Limit Amount programmed here, all the amount subject to either of the two taxes are all taxed. When the sum is less than the programmed limit, Tax 1 is tax-exempted and only Tax 2 is calculated on the sale portion subject to Tax 2.*
 2. *When the sum of the sale portion subject to Tax (PST) 1 and the sale portion subject to Tax (PST) 2 is negative, the portion subject to Tax 1 will not be taxed.*
 3. *When the sale portion subject to Tax 1 is tax-exempted, the taxable amount is not stored in Tax 1 memory.*
 4. *An error results when the [GST/M] key is depressed in sale entries on the ECR with Non-taxable Limit Amount programmed.*

Tax Calculation Test

Tax calculation can be tested by the following procedure. This operation will not affect any sales data.

Operating Procedure:

Use the **MA Key** to turn the Control Lock to “X”.

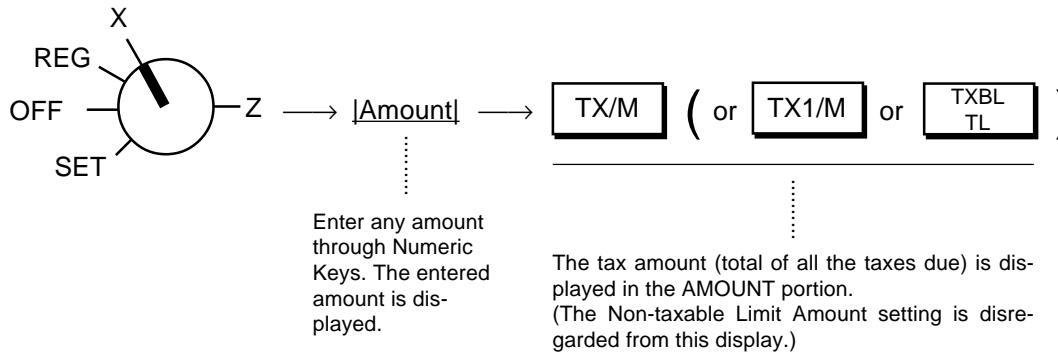



11. Optional Key Setting

This chapter introduces optional keys (keys not installed on the current Standard Keyboard) that can be programmed. Please note, however, that adding an optional key means to sacrifice another key already installed. If you plan to install any of the Optional Keys or change locations of any of the current keys, this operation must be performed first before any other programming or setting operation (refer to **NOTE 9** at the end of this chapter).

List of Keys

The following is the list of the all the keys that can be programmed on the keyboard. Numeric Keys **0** to **9** are fixed as to their locations, therefore, not included in the list. The “Key Code” assigned to each key in the lists used in the setting procedure next page. For detail functions and operations of each key, refer to Chapter “**14. Setting Preparation of Each Key and Transaction Entries**” on page 27. For a brief information of the Optional Keys, refer to **NOTE 8** at the end of this chapter.

-  Keys that must be installed as minimum requirement
-  Keys that are already installed on the Standard Keyboard
-  Optional Keys

(All those keys, not only the Optional Keys, can be eliminated or changed as to their locations on the keyboard. However, please do not eliminate the keys of minimum requirements.)

Key Code	Key Name	Key Code	Key Name
0	Code to deactivate the key	85	NS (No-sale) *2
*1 1 to 20	Department Keys 1 to 20	87	LC OPEN (Listing Capacity Open)
61	FEED (Paper Feed)	90	#/CID (Non-add Number/Cash-in-drawer) *2
63	00 (Double-zero)	91	#/NS (Non-add Number/No-sale) *2
65	• (Decimal Point)	92	PLU (Price-Look-Up)
69	DOLL DISC (Dollar Discount)	93	@/FOR (At/For; Multiplication)
70	%+ (Percent Charge)	94	RECEIPT ISSUE (Post-receipt)
71	%- (Percent Discount)	95	C (Clear)
72	RTN MDSE (Returned Merchandise)	97	TX/M or TX1/M (Tax 1 Modifier)
73	ITEM CORR (Item Correct)	98	TX2/M (Tax 2 Modifier)
74	VOID (Void)	99	TXBL TL (Taxable Total)
75	ALL VOID (All Void)	100	TAX (Manual Tax) *3
76	AT/TL (Cash Tender/Total)	101	EX (Tax Exempt)
77	CHK TND (Check Tender)	107	DPT SHIFT (Department Shift) *4
78	Chg (Charge Total)	108	AMT (Amount)
82	ST (Subtotal)	109	REPEAT (Repeat)
83	R/A (Received-on -Account)	115	GST/M (GST Modifier)
84	PO (Paid Out)	127	LOG/RECEIPT (Log/Receipt) *5

- *1. At least one Department Key is required to be installed.
- *2. The **[#/NS]** key has both **[#/CID]** and **[NS]** functions. Therefore, when **[#/NS]** is installed, neither **[#/CID]** nor **[NS]** are necessary. (At least, either **[#/NS]** or **[#/CID]** must be installed.)
- *3. To designate the SFKC 100 for the **[TAX]** key (Manual Tax), operate the keys **[1]** → **[0]** → **[0]**. In this case, the **[00]** key is unavailable.
- *4. The **[DPT SHIFT]** key designates the Department Nos. 21 to 40, using the Department keys 1 to 20.
- *5. When the Cashier Signing Method is selected, this key must be installed. If this optional function is not selected, this key merely functions as Receipt ON/OFF key.

Key Installation Setting

Condition: After all Daily and Periodical Resets; refer to “**NOTE on Condition**” on page 15.

Setting Procedure:

Use the **S Key** to turn the Control Lock to the “**BLIND**” position.

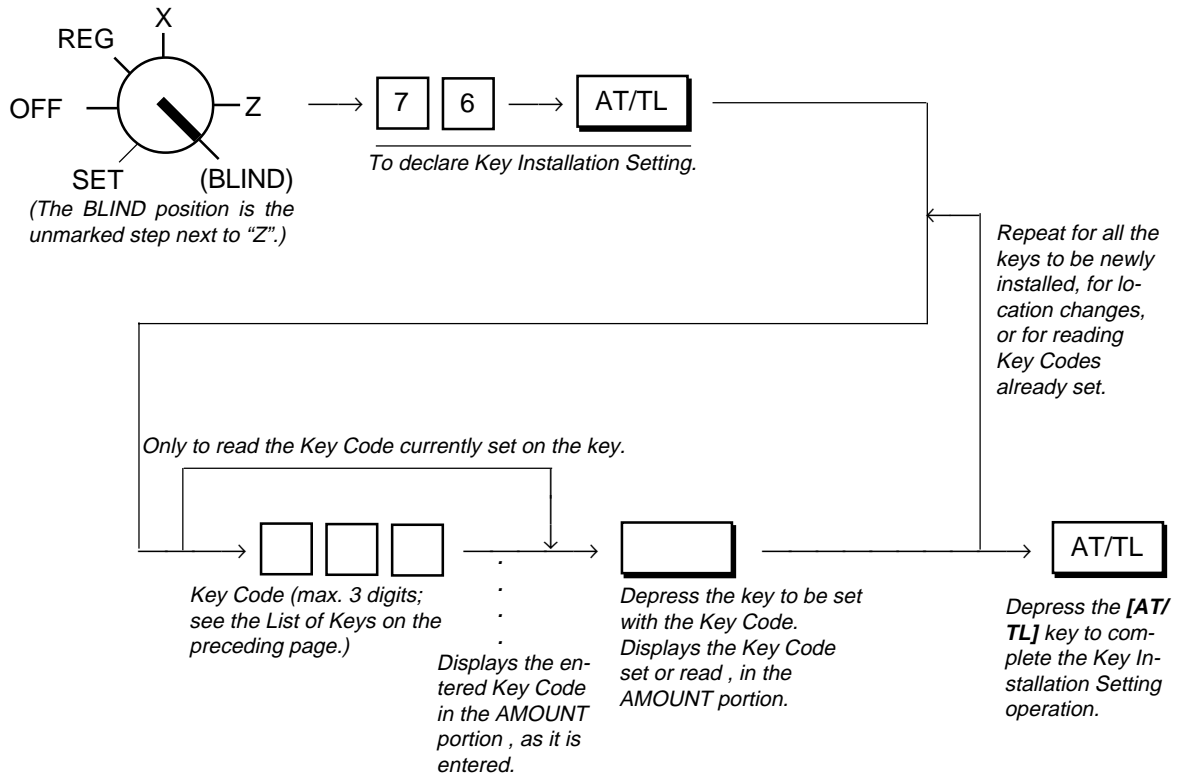

Blank Keyboard Sketch (for your planning aid)

Fill in:
 Key Name
 →
 Key Code
 →
 (Refer to the “**List of Keys**” on the preceding page.)

 For the Standard Keyboard Layout, refer to Chapter “**7. Keyboard**” on page 9.

()	()
()	()
()	()
()	()
()	()



()	()	()
()	()	()
7	8	9
4	5	6
1	2	3
0	()	()

()	()	()	()	()
()	()	()	()	()
()	()	()	()	()
()	()	()	()	()
()	()	()	()	()
()	()	()	()	()
()	()	()	AT/TL	

- NOTES:**
1. If Key Installation Setting is operated for the first time, all the keys are already set as in the Standard Keyboard Layout. Therefore, set only the keys that are to be changed as to their locations or newly installed.
 2. If a wrong code has been entered and the key has also been depressed (i.e., a wrong code has been set on a key), enter the correct code and depress the key. The code entered last will be effective.
 3. If "0" is entered as Key Code, the key will be dead and its memory will also be closed.
 4. Each of the keys programmed in this operation will have its memory (if any) opened automatically.
 5. The **[C]** key, if once set with Key Code 95, may be used to clear an error, but it cannot be used immediately after a Key Code entry (for the purpose of clearing the wrong Key Code error). If any Key Code is entered and then the **[C]** key is depressed, that Key Code will be set on the key that was once the **[C]** key.
 6. On depressing the final **[AT/TL]** key, "0.00" is displayed in the AMOUNT portion, indicating that the setting operation is completed. No printing occurs.
 7. Use the Blank Keyboard Layout on the preceding page, if necessary, for your own keyboard plan before starting the setting procedure.
 8. Brief Information on Optional Keys:
 - [/NS]** (Non-add Number Print/No-sale Key)
It is unnecessary if the **[/CID]** key and the **[NS]** key have already been installed. This **[/NS]** key has a double function performed by the above two keys.
 - [%+]** (Percent Charge Key)
It is used to add a percent rate, preset or manually entered, to a sale or each sale item.
 - [LOG/RECEIPT]** (Log/Receipt Key)
It is used for the cashier sign on/off operation when the cashier signing method (optional function) has been selected. Also, used to select the receipt issue or non-issue without entering numbers.
 - [RECEIPT ISSUE]** (Post-receipt Key)
It is used to print the receipt of the last sale completed in registration.
 - [TX2/M]** (Tax 2 Modifier Key)
It is necessary in the dual-tax (PST) area, in addition to **[TX1/M]**, for reversing the Tax 2 taxable/non-taxable status of items.
 - [TAX]** (Manual Tax Key)
It is used to enter an irregular tax amount.
 - [EX]** (Tax Exempt Key)
It is used to exempt designated tax(es) from a sale.
 - [GST/M]** (GST Modifier Key)
It is necessary in the GST-applicable area in Canada. It reverses the GST taxable/non-taxable status of items.
 9. If any of the following keys are newly installed or location is changed, its relevant programming operations are further required (even if once programmed, re-programming is necessary because the program data has been cleared):
 - Each Department Key** Department Status, LC (if required), Preset Price (if required) of the Department
 - [PLU]** PLU Table
 - [%+], [%-]** Respective Preset % Rates (if required)
 - [TX(1)/M], [TX2/M], [GST/M]** Respective Tax Tables or Rates (Tax 1, Tax 2, GST)

12. Daily Operation Flow

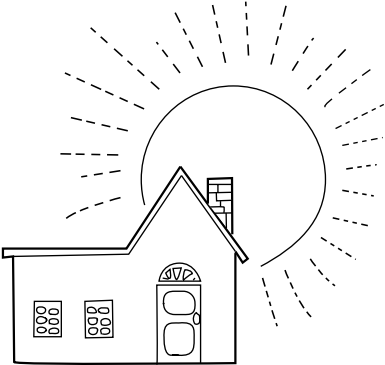
The following shows a typical daily operation flow on the register.

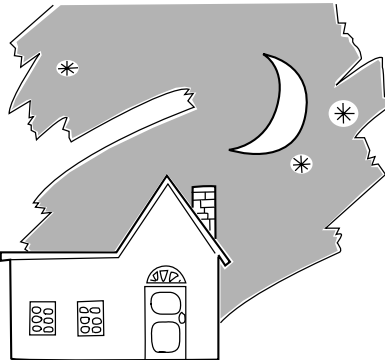
Before Opening the Store ...		<i>Reference Chapter</i>
	<ul style="list-style-type: none"> • Ensure that the register is firmly plugged in the wall outlet. • Check if enough portion of paper roll is left. • Check the time, date, and print condition. <ul style="list-style-type: none"> Check the time, date, and print by issuing a No-sale Receipt. ... Setting the time or date ... 	<p>3</p> <p>8</p> <p>14</p> <p>9</p>
During Business Hours ...		
	<p style="text-align: center;"><i>Opening the store</i></p> <ul style="list-style-type: none"> • Transaction entries on the register • Taking Read (X) Reports periodically. <p style="text-align: center;"><i>Closing the store</i></p>	<p>14</p> <p>15</p>
After Closing the Store ...		
	<ul style="list-style-type: none"> • Taking Daily Reset (Z) Reports • Tear off the print portion of Journal Paper (optional). • Leave the drawer open, and turn the Control Lock to "OFF". • Take all the cash and other contents from the drawer to the office with the torn Journal and printed Reset Reports. 	<p>15</p> <p>20</p> <p>20</p> <p>20</p>

13. Training

This chapter describes a training provided for new employed cashiers. After entering the training mode, a cashier may operate the same transaction entries as those in the **REG** mode. The data in the training mode is processed to the Electronic Journal buffer when selecting the Electronic Journal function, however not affect any actual sales data in business. As for the details of the Electronic Journal, refer to Chapter “**18. Electronic Journal (E. J.) Print (optional function)**” on page 83.

- Turn the Control Lock to the **SET** position using the **MA** key.
- In the operation patterns, indicates an input through a numeric key, and indicates a depression of a transaction key.
- The receipts shown as sample receipts will be printed when Receipt-format option is selected.

OPERATION FOR TRAINING MODE START

9 9 AT/TL A training start receipt is issued.

ENTRIES IN TRAINING MODE

When the cashier signing option is selected, a sign ON is required before starting operations. Refer to Chapter “**17. Cashier Signing Operation (optional function)**” on page 82 on how to sign ON.

A trainee can operate all transaction entries described in the next chapter.

except: 1) The drawer will not open.
2) The consecutive No. will not be incremented.

When the cashier signing option is selected, a sign OFF is required after completing operations. Refer to Chapter “**17. Cashier Signing Operation (optional function)**” on page 82 on how to sign OFF.

OPERATION FOR TRAINING MODE END

9 9 AT/TL A training end receipt is issued.

Training Start Receipt -----> Training End Receipt

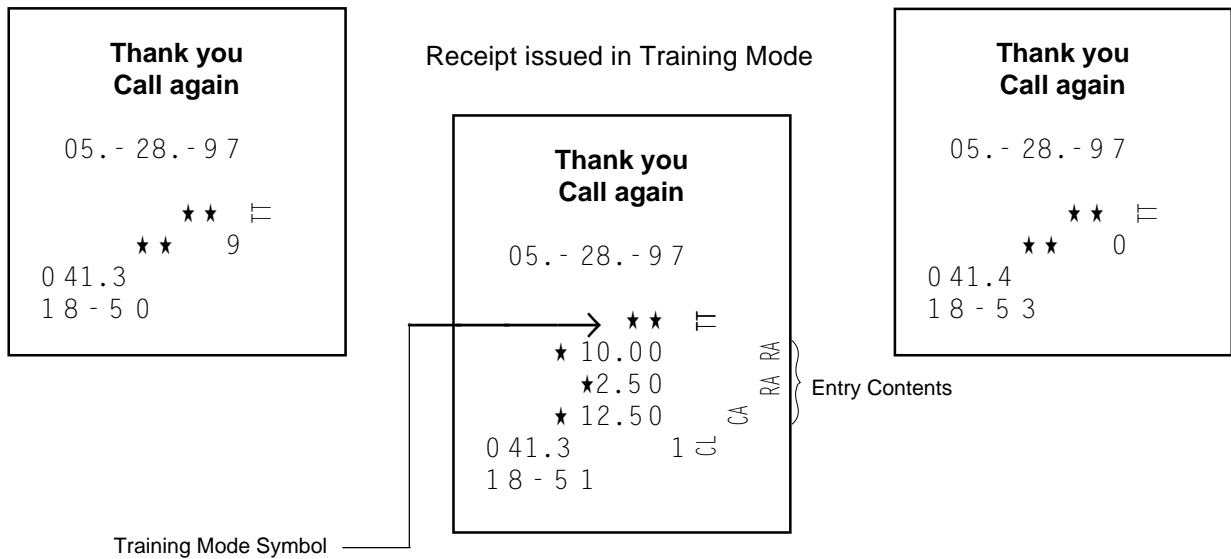

14. Setting Preparation of Each Key and Transaction Entries

This chapter describes individual key operations on transaction entries, and setting requirements for the key if necessary.

WARNING!

When opening the cash drawer, be careful not to let the drawer hit any person.

Receipt-issue/Non-issue Selection

 (Log/Receipt Key)

Receipts are issued or not issued according to the "R OFF" triangular lamp illuminated/extinguished status on the Operator Display panel.

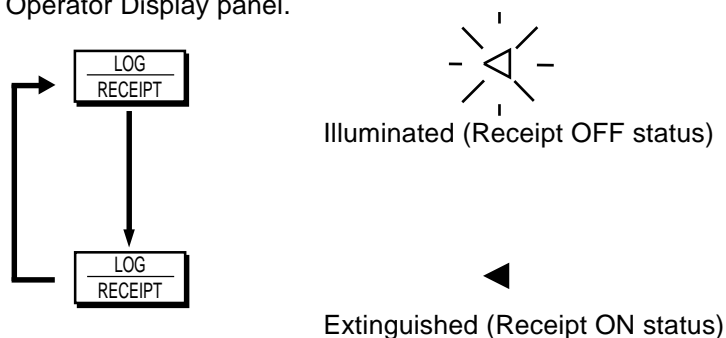

- NOTES:**
1. The Control Lock may be in any position (except **OFF** position) for changing the Receipt ON/OFF status in the signed-ON or signed-OFF condition.
 2. The "R OFF" lamp status at the starting of a transaction entry decides whether a receipt will be issued for the transaction or not. Switching the Receipt ON/OFF status during a transaction will not be effective.
 3. This operation is effective only when the Receipt-format Option has been selected. When the Journal-format Option has been selected, journal printing will occur regardless of any "R OFF" lamp status.

4. If a transaction entered with the "R OFF" lamp illuminated and finalized but a receipt is required, the **[RECEIPT ISSUE]** (Post-issue Receipt) key can be operated to issue a receipt (see "**Post-issue Receipt**" on page 55).
5. Simply depress the **[LOG/RECEIPT]** key without a numeric entry. If the key is depressed with a prior numeric entry in **REG** mode, it may turn out to be a Sign ON or Sign OFF operation (refer to **Chapter 17** on page 82).

Clearing Errors, or Clearing Wrong Declaration Key or Wrong Numeric Entries

C (Clear Key)

When in sale entries an error has occurred with an alarm buzzer (beeps for about 2 seconds only), a wrong Declaration Key (such as **[RTN MDSE]**, **[TX/M]**, **[GST/M]**, etc.) has been depressed, or a wrong numeric data has been entered; depress the **[C]** key.

- | | | | | |
|--|---|--|--|---|
| <p>1) Error has occurred (the alarm buzzer is generated and the "ALM" lamp illuminates), and the keyboard is locked.</p> | → | C | → | <p>The error condition is cleared (the buzzer tone stops and the "ALM" lamp is extinguished). Find the cause of the error, and do the operation again. Refer to "Possible Cause of Error" attached where an error may occur in each operation sequence on the following procedure.</p> |
| <p>2) Declaration Key has been depressed.</p> <p>ex.) RTN
MDSE</p> | } | | | |
| <p>3) Numeric Keys are entered.</p> <p>ex.) 5 0 0</p> | | | | |
| <p>4) Declaration Key(s) + Numeric Keys</p> <p>ex.) RTN
MDSE 7 0</p> | | → | C | → |
| <p>5) Numeric Keys + Non-motorized Key (key that does not trigger printing)</p> <p>ex.) 1 2 X</p> | | | | |
| <p>6) Combination of 2) to 5)</p> | | | | |
| <p>7) Combination of 6) + 1)</p> | → | C | → | <p>The entered data are all cleared at once, and the error condition is cleared also. Refer to 1) for finding the cause of error.</p> |

NOTE: When data is already entered and printed (through a Department Key, etc.), it cannot be cleared by the [C] key any longer. In need of deleting such data, see the following:

- Item Correction (Last Line Voiding) ITEM
CORR page 49
- Void (Designated Line Voiding) VOID page 50
- All Void (Transaction Line Voiding) ALL
VOID page 51

Furthermore, for details to clear various troubles and errors, refer to Chapter “22. Troubleshooting” on page 100.

No-sale (Exchange)
 <operable outside a sale only>

NS (No-sale Key)
#/NS (Non-add Number Print/No-sale Key)

The No-sale transaction is used to open the drawer without relating to a sale, for such purposes of giving changes (to break a large-amount bill), checking the receipt/journal print condition, date or time accuracy, etc. This operation must be performed outside a sale only.

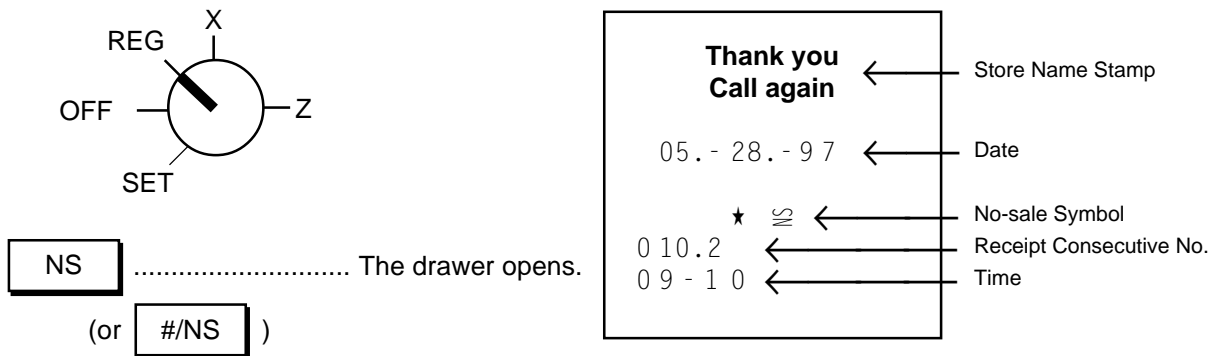

- NOTES:**
1. Usually, Non-add Number entries are prohibited at the starting of a No-sale transaction (i.e. Non-add Numbers cannot be printed on a No-sale receipt). However, a No-sale entry can be programmed to be allowable after a Non-add Number entry. (Refer to Chapter “16. System Option Setting”, Address 15-Bit 1 on page 80.)
 2. The [#NS] key operates and functions the same. When this key is depressed with a prior number entry, it functions as the Non-add Number Print key. (Refer to the section of Non-add Number Print on page 52.)

Received-on-Account Payment
<operable outside a sale only>

R/A (Received-on-Account Key)

A received-on-account transaction is used to identify money which is in the drawer but not due to business. For example, a customer pays for a sale finalized as a charge on a past day, or the cashier records the change reserve in the drawer loaned from the store office. This operation must be performed outside a sale only.

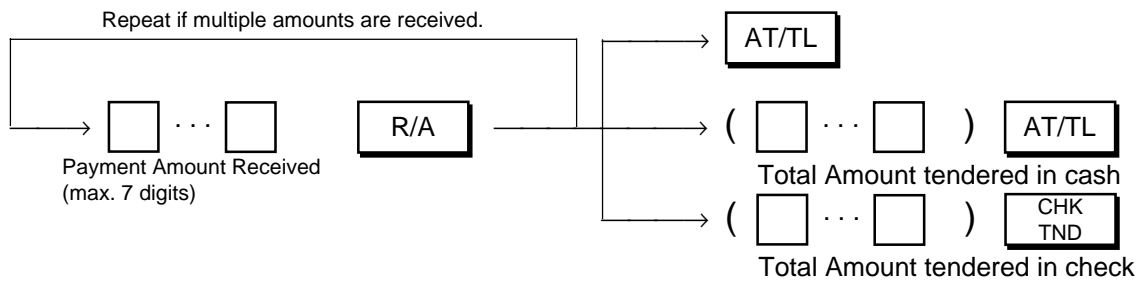
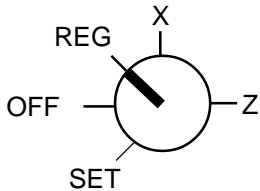

NOTE: For finalizing the transaction, the **[Chg]** key cannot be used. For further operation using the media key, refer to the section **"Finalizing a Sale"** on page 54.

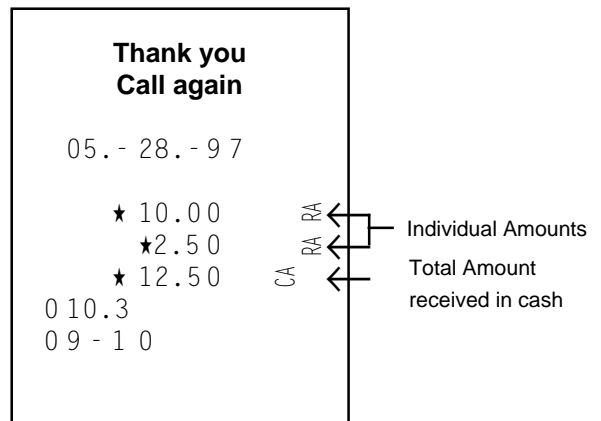

Paid Out
<operable outside a sale only>

PO (Paid Out Key)

A paid-out transaction is used when an amount of money is removed from the drawer without relating to a sale, for the purpose of paying to wholesalers, etc. This operation must be performed outside a sale only.

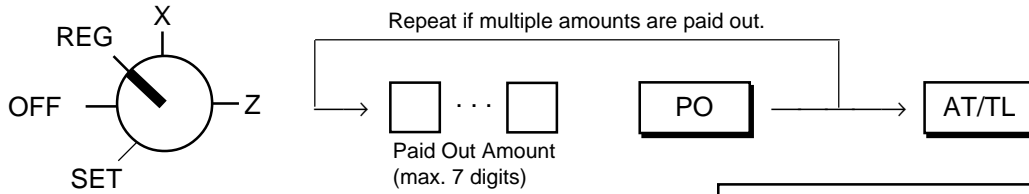

NOTE: For finalizing the transaction, only the **[AT/TL]** key can be used. (i. e. only cash can be paid out) without entering a prior amount.

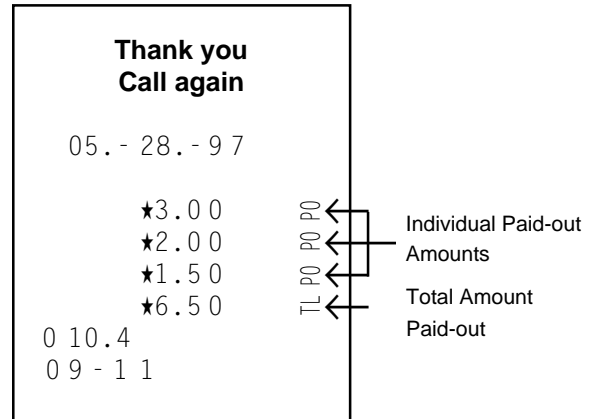

Department Keys

21 / **Dept. 1** to **40** / **Dept. 20**, **DPT SHIFT** to control Dept. Nos. 21 to 40

Programming Department Keys

These are department keys through which sales items are registered. 40 departments can be used. To designate the Department Nos. 21 to 40, pressing the **[DPT SHIFT]** key before the Department Keys 1 to 20 is necessary.

Department Status Programming:

To use Department Keys, program how each Department Key is to be used, in accordance with merchandise categories, operativity of the key, etc.

Condition: After Daily Financial Reset and Periodical Financial Reset (and All PLU Reset if the positive/negative status is to be set), or Any time outside a sale for other status changes. (refer to **“NOTE on Condition”** on page 15)

Programming Procedure:

Use the **MA Key** to turn the Control Lock to **“SET”**.

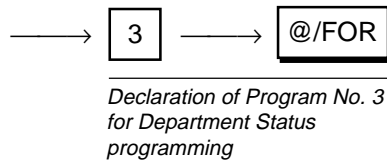
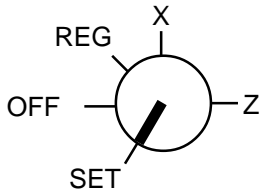

Repeat for programming other Department Keys.

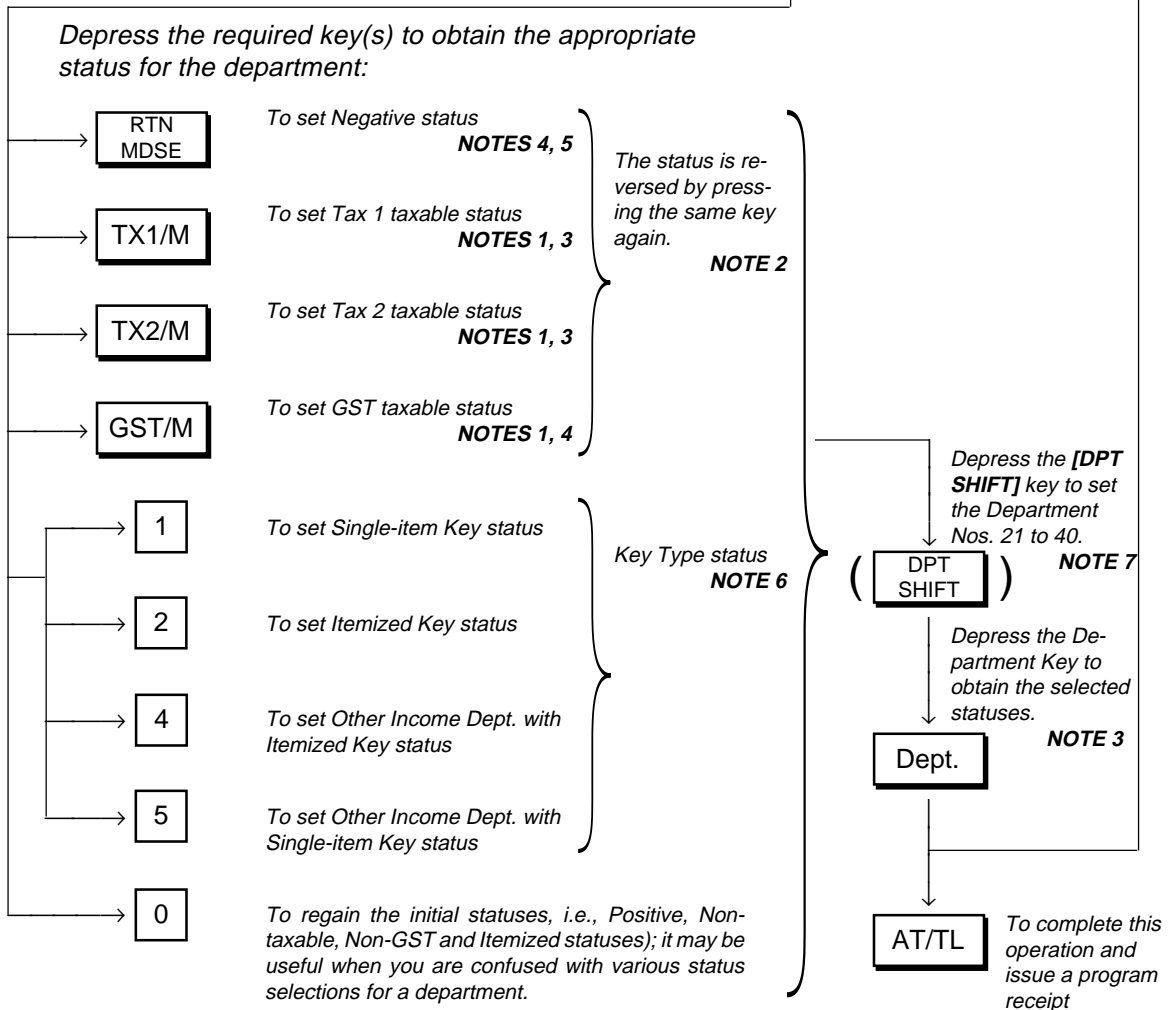

- NOTES:**
1. The tax tables of "Tax 1", "Tax 2", and "GST" should be programmed in Chapter "12. Tax Table Setting" on page 20. Those tax tables will become effective in **REG** mode for adding the taxes to sale items entered through a Department Keys only when the Department Key is programmed with taxable status for the required tax in this operation.
 2. Every time each of the **[RTN MDSE]**, **[TX1/M]**, **[TX2/M]**, and **[GST/M]** keys in this operation is pressed, the preset status is reversed. For example, if a Department Key is already set with "Tax 1 Taxable" status and the **[TX1/M]** key is pressed during the setting sequence of that Department Key, it is now set with "Tax 1 Non-taxable" status. If **[TX1/M]** is again pressed, "Tax 1 Taxable" status is again obtained.
 3. The tax (PST) status obtained (as the result of **[TX1/M]** and/or **[TX2/M]** depressions) can be verified by reading the numeric value displayed in the rightmost digit of the AMOUNT portion when the individual Department Key is pressed. Similarly, the Key Type status is displayed in the 2nd digit (next to the rightmost digit).

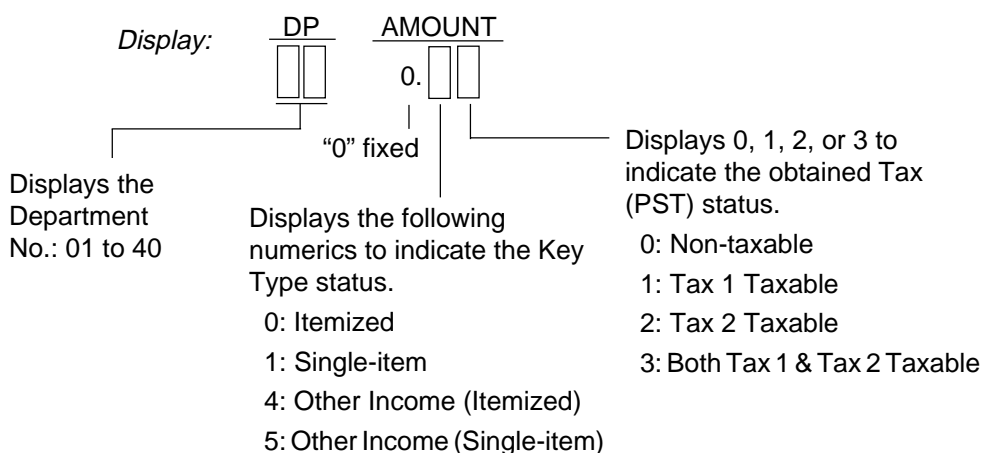

(These status codes are also printed on the program receipt issued when the final **[AT/TL]** key is pressed; refer to the Receipt Format on next page.)

4. The Negative/Positive status and GST status can only be verified on the program receipt (refer to next page) but not in the display. If a wrong status has been set, correct it by performing the programming operation again.
5. If a Department Key is set with Negative status, an amount entered through that key will be subtracted from the sale total. It may be used for item entries of coupons, returned bottles, etc.
6. Key Type Description.

Itemized Key: When a sale item amount is entered through this key, the sale is not finalized until a media key (such as **[AT/TL]**) is operated. Other items can be entered within one sale receipt sequence.

Single-item Key: A sale item entry through this key will automatically finalize the sale as cash outside a sale (i.e. when no other items have been entered within one receipt sequence). However, it will function just as an Itemized Key if operated inside a sale.

Other Income Key: It is used to enter items which do not directly become sales for the store, such as lottery, postage, gift wrapping fee, size adjustment fee, utility (payment of electricity and gas), and donation.

7. To set the Department Nos. 21 to 40 (No. printed on the upper side of a Department Key Sticker), depress the **[DPT SHIFT]** key before depressing a **[DEPT]** key.

ex.) To set the Department No. 21, operate **[DPT SHIFT]**, then **[DEPT 1]**.

Department Status Program Receipt Format:

Key Operation

Control Lock: **SET**

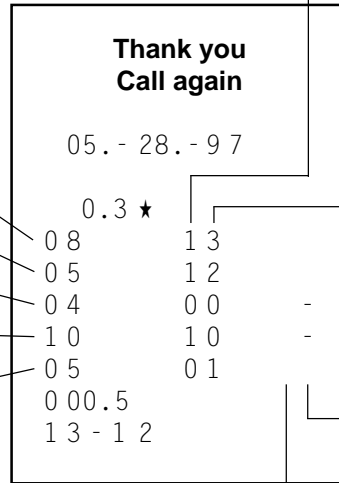
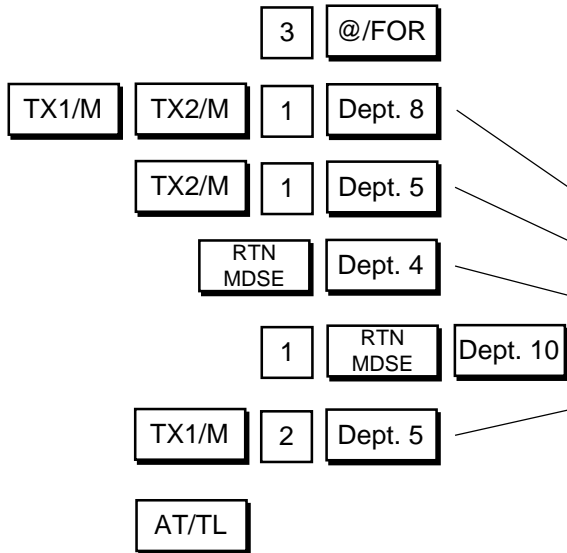

Key Type Status
 0: Itemized
 1: Single-item
 4: Other Income (Itemized)
 5: Other Income (Single-item)

Tax Status (PST)
 0: Non-taxable
 1: Tax 1 Taxable
 2: Tax 2 Taxable
 3: Both Tax 1 & Tax 2 Taxable

Positive/Negative Status
 Blank: Positive
 - : Negative

GST Status
 TM: GST Taxable
 Blank: GST Non-taxable

Department LC (Listing Capacity) Programming:

The LC setting is used to check an amount limit error. By setting the LC, an amount entry (due perhaps to a mistake by the operator) will be prevented at the earliest stage (i.e., an error will result on entering an excessive amount through the department key).

Condition: After Daily Financial Reset (refer to "NOTE on Condition" on page 15)

Programming Procedure:

Use the **MA Key** to turn the Control Lock to "SET".

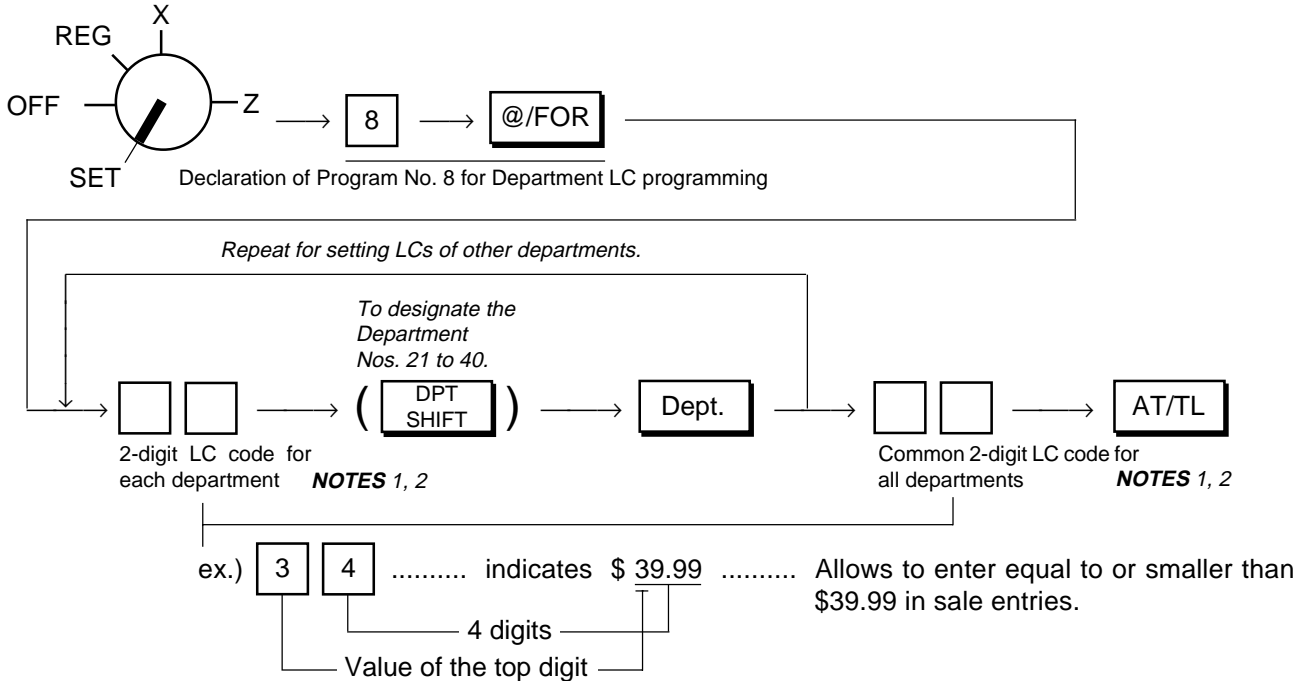

- NOTES:** 1. If the individual LC of a department is set, it prevails over the common LC for all departments.
2. To reset a LC once set, enter "0" in place of the 2-digit LC code. Then a maximum of 7-digit amount can be entered in sale entries.

Department LC Program Receipt Format:

Key Operation

Control Lock: **SET**

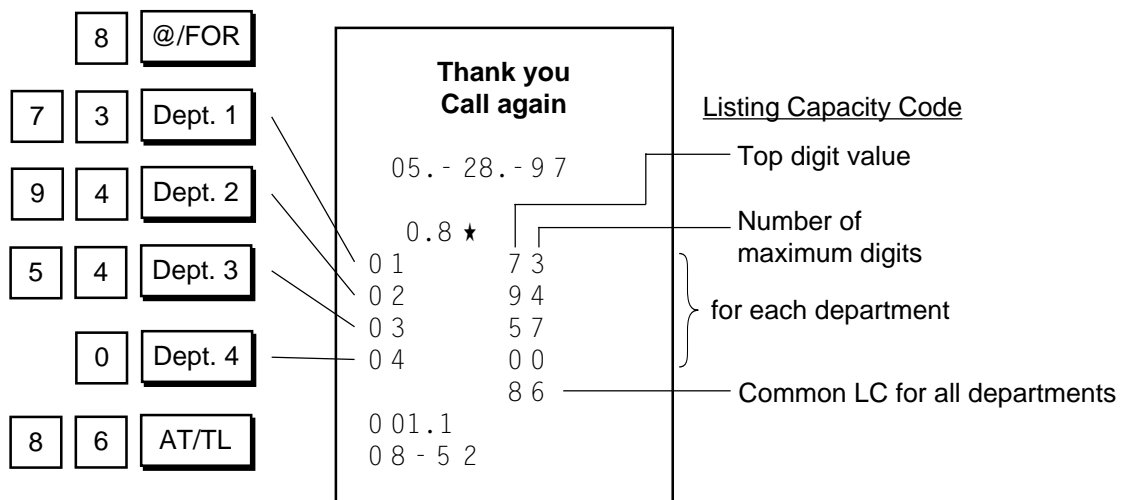

Department Preset Price Setting:

If a fixed price is always entered through a Department Key in sale entries, a preset price can be set on the Department Key. Please note that once set with a preset price, the Department Key will not accept any other price (open price) until the Department Key is again programmed to be an open department.

Condition: Any time outside a sale

Setting Procedure:

Use the **MA Key** to turn the Control Lock to "SET".

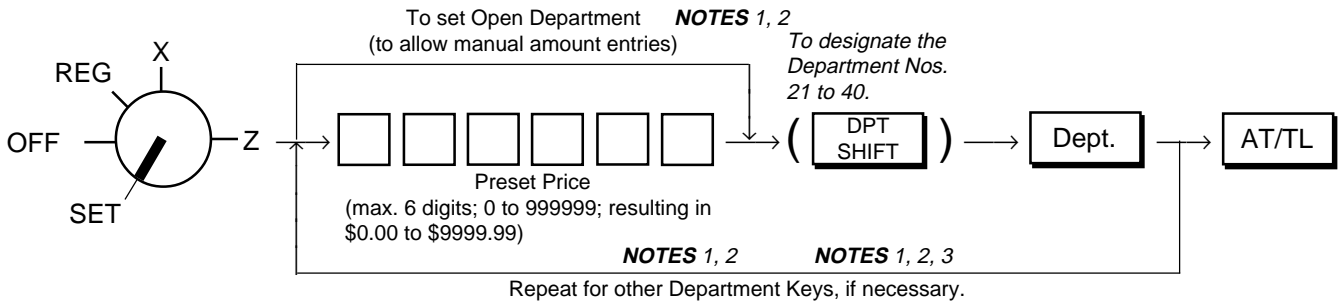

- NOTES:**
1. All the Department Keys are open departments (no preset price set) as initial status.
 2. If a Department Key is pressed with no Preset Price entry, the Key is set as an open-price Department Key.
 3. If "0" is entered as Preset Price, the Department Key is set with Preset Price of \$ 0.00.

Department Preset Price Setting Receipt Format:

Key Operation

Control Lock: **SET**

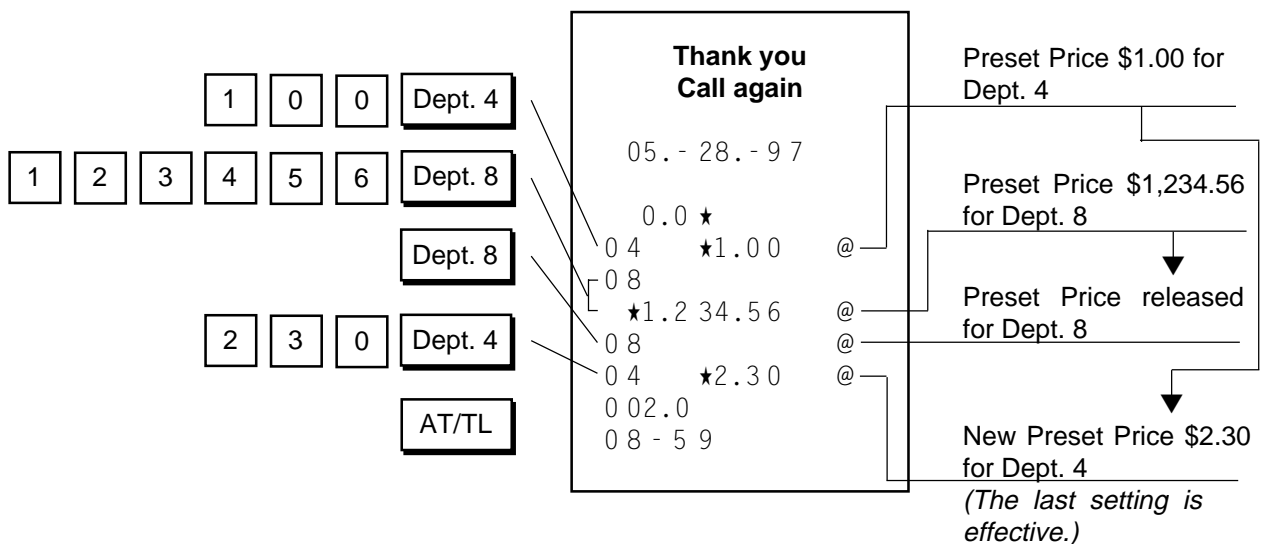

Sale Item Entries Using Department Keys

Various types of department entries are shown below.

Use the **REG Key** to turn the Control Lock to "REG".

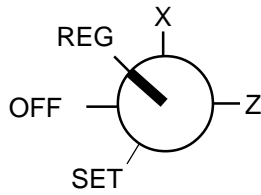

Entry of One Item

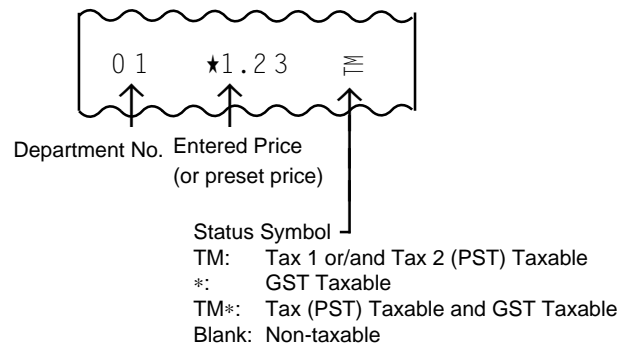
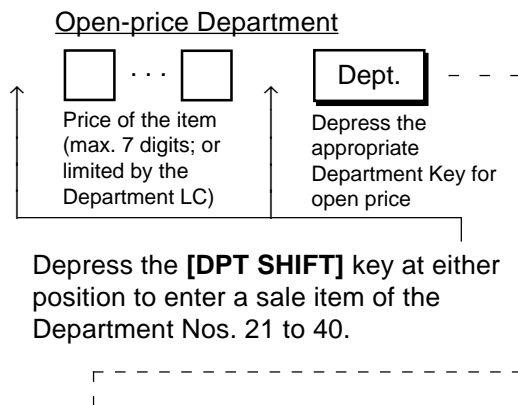

If an error occurs here:

Possible cause of error:

- The price entered exceeds the LC.
→ See the **Listing Capacity Open Entry** on page 46.
- The Department Key is a preset-price key.
→ Use an open-price Department Key, or see the "Preset-price Department" entry procedure below.

Preset-price Department

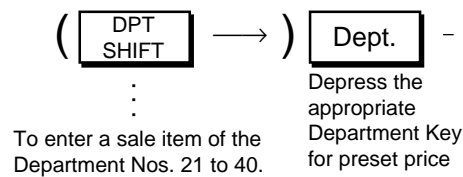

If an error occurs here:

Possible cause of error:

- The Department Key is an open-price key.
→ Use a preset-price Department Key, or see the "Open-price Department" entry above.

Repeat Entry

Open-price Department (Nos. 1 to 20)

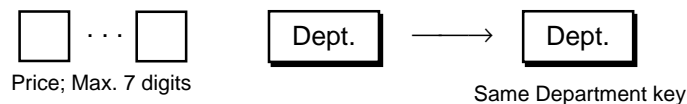

Preset-price Department (Nos. 1 to 20)

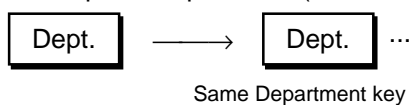

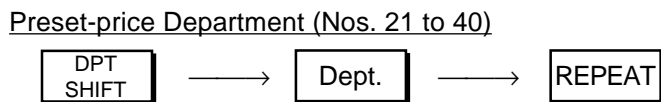
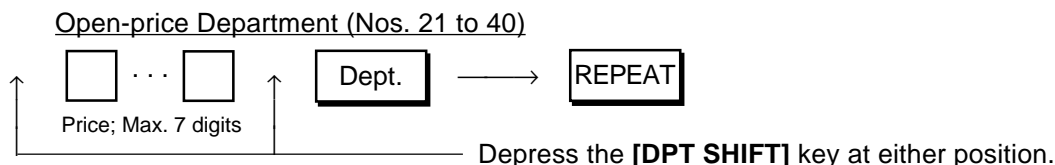

NOTE: A negative department cannot be repeated.

Quantity Extension (Multiplication)

Open-price Department

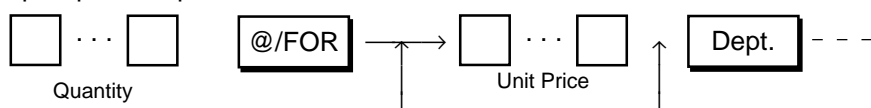

Depress the [DPT SHIFT] key at either position to enter a sale item of the Department Nos. 21 to 40.

- If an error occurs here:**
Possible cause of error:
- Exceeding the LC of the Department
 - Check the Unit Price.
 - See **Listing Capacity Open** on page 46.
 - Product exceeding 7 digits.
 - Check the Quantity and Unit Price.

Preset-price Department

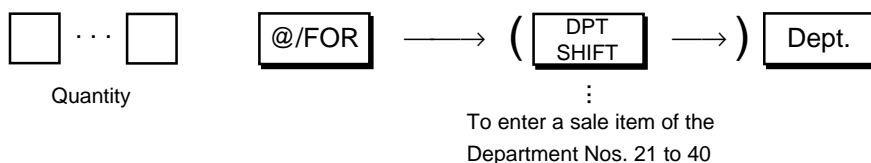

- If an error occurs here:**
Possible cause of error:
- Product exceeding 7 digits.
 - Check the Quantity.

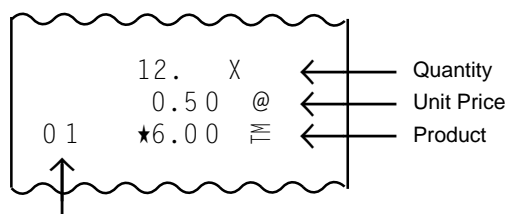

- NOTES:**
1. Quantity... Max. 6 digits (Max. 3 digits for integer + max. 3 digits for decimal. Use the [.] key if a decimal portion is contained.)
Unit Price ... Max. 6 digits
Product (result of multiplication) ... Must not exceed 7 digits.
 2. When the Quantity is 1-digit integer (1 to 9) and a Preset-price Department key follows, the [@/FOR] key is omissible.
 3. The decimal portion of the Quantity entry is processed down to the 2 digits below the decimal point. The fraction rounding at this time is fixed to ROUND OFF.
 4. You can select the rounding process of the fractions of the product—ROUND OFF (initial setting), ROUND UP, or ROUND DOWN. (Refer to Chapter "16. System Option Setting", Address 2 - Bits 1 and 2 on page 72.)

Split-Package-Pricing (Department SPP)

This operation is used when a customer purchases only part but not all of the items in a package (example: only two tomatoes in a priced package of three tomatoes).

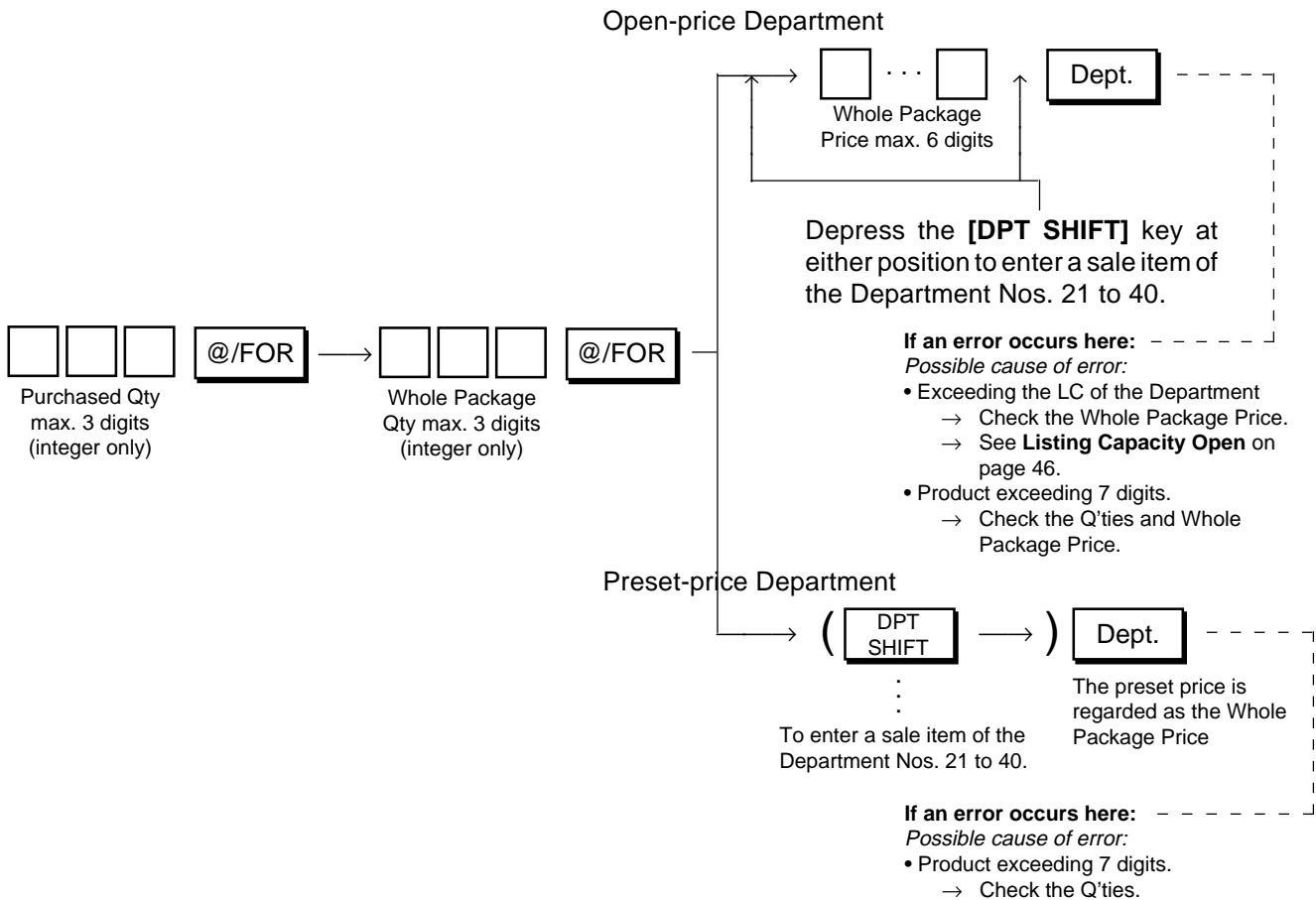

- NOTES:**
1. The product (final result amount) obtained by SPP (Split-Package-Pricing) cannot be repeated.
 2. The product must not exceed 7 digits.
 3. The rounding process of the fractions of the product resulted from the calculation is fixed to ROUND UP (the final result amount is rounded up).
 3. SPP is not possible using PLUs.

Example)

Purchased Quantity = 2
Whole Package Quantity = 3
Whole Package Price = \$1.00
Entered through Dept. 1
(open-price, Taxable department)

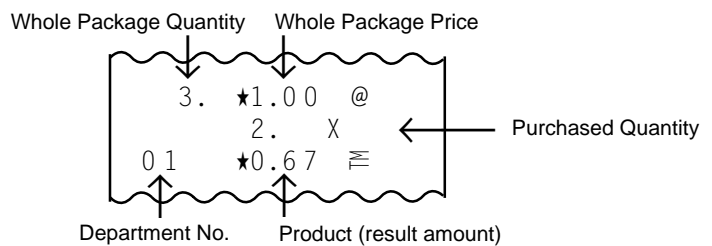

2 @/FOR 3 @/FOR 1 0 0 Dept. 1

Single-item Department Entry

If a Department key is programmed with single-item status, an entry through the key immediately finalizes the sale as cash without operating a Media key.

The operation is the same as ordinary itemized Department keys already described (Entry of One Item, Quantity Extension, Split-Package-Pricing).

NOTE: *A sale item entry through this key will automatically finalize the sale as cash outside a sale (i. e. when no other items have been entered within one receipt sequence). However, it will function just as an Itemized Key if operated inside a sale.*

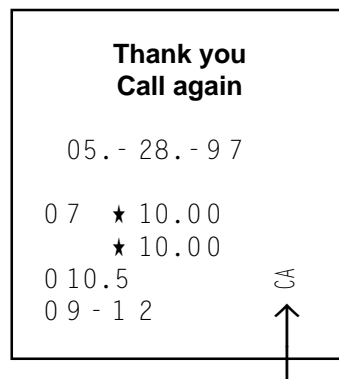

Automatically finalized as cash sale (Cash Total)

Other Income Department Entry

This operation is used to enter items which do not directly become sales for a store, such as postage, utility (payment of electricity and gas), and donation.

The operation is the same as ordinary itemized Department keys already described (Entry of One Item, Repeat Entry, Quantity Extension)

PLU (Price-Look-Up) (PLU Key)

PLU

(PLU Key)

A "PLU" is an individual merchandise item programmed with its own item code (PLU Code), its link department (and mostly with a Preset Price). By programming PLUs, you can enter an individual item by entering its PLU Code (which should be written on the price tag of the item), instead of entering the price through a Department Key. By taking PLUs Reports, you can analyze the sales data of each individual item. A maximum of 500 PLUs can be programmed.

Programming PLUs

PLU Table Setting:

Condition: *To change setting of a PLU:* When the required PLU sales total memory is zero (i.e., when no sales are made or after a PLU Reset Report is taken to reset the sales data of the PLU into zero)

To add new PLUs: Any time outside a sale.
(refer to "**NOTE on Condition**" on page 15)

Programming Procedure:

Use the **MA Key** to turn the Control Lock to "SET".

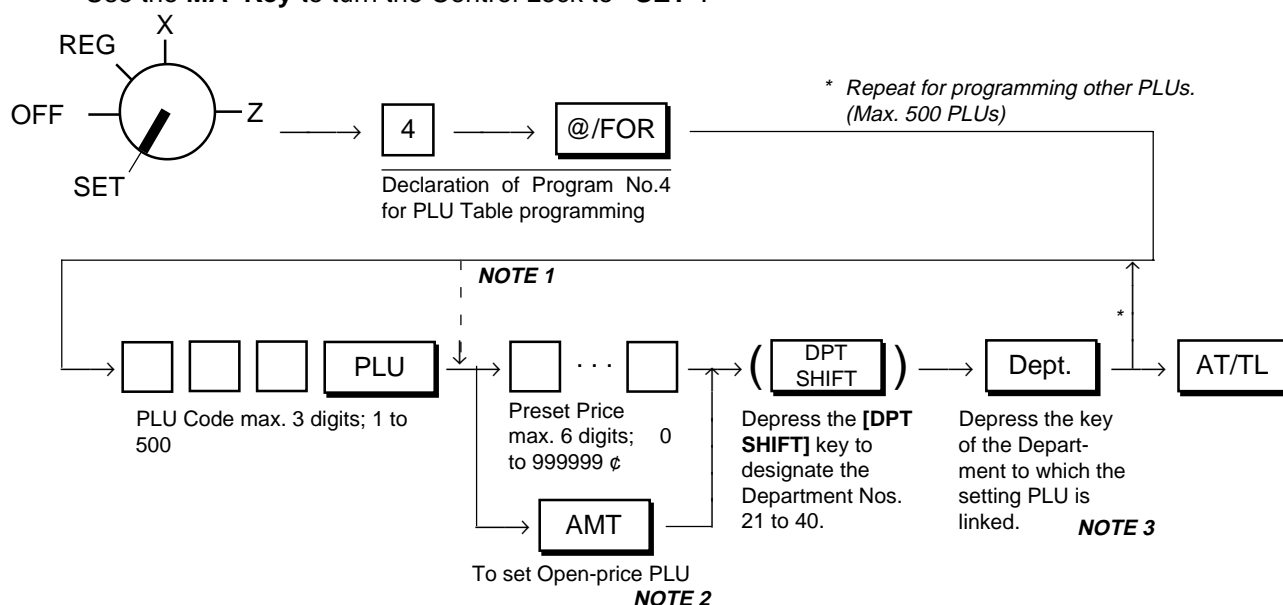

- NOTES**
1. When sequentially programming the PLUs, the code specification can be omitted. When it is omitted at the very first PLU, PLU Code "1" is automatically assigned.
 2. An Open-price PLU always requires a price entry through Numeric Keys in sale entries, and may be used for an item that frequently changes its price.
 3. The statuses (Positive/Negative Status, Tax (PST) 1 & 2 Status, GST Status, and Key Type Status) of each PLU is decided by the statuses of the statuses of the Department to which the PLU is linked.
 4. When a PLU is linked to an Other Income Department, an entry of the PLU in a sale will cause an error.

PLU Table Program Receipt Format:

Key Operation

Control Lock: **SET** **4** **@/FOR**

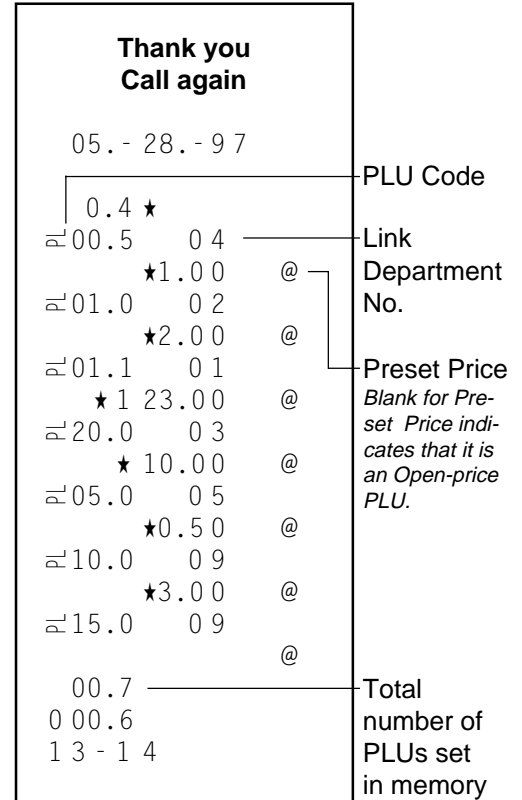
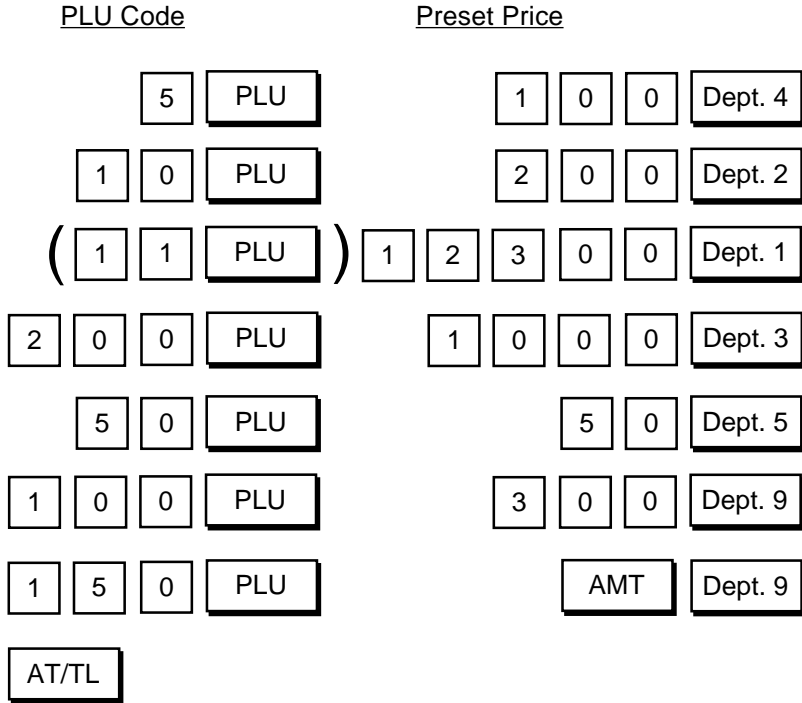

Deleting Individual PLUs:

When any of the PLUs once programmed are not handled any more in the store, they can be deleted.

Condition: When the required PLU sales total memory is zero (i.e., when no sales are made or after a PLU Reset Report is taken to reset the sales data of the PLU into zero)

Programming Procedure:

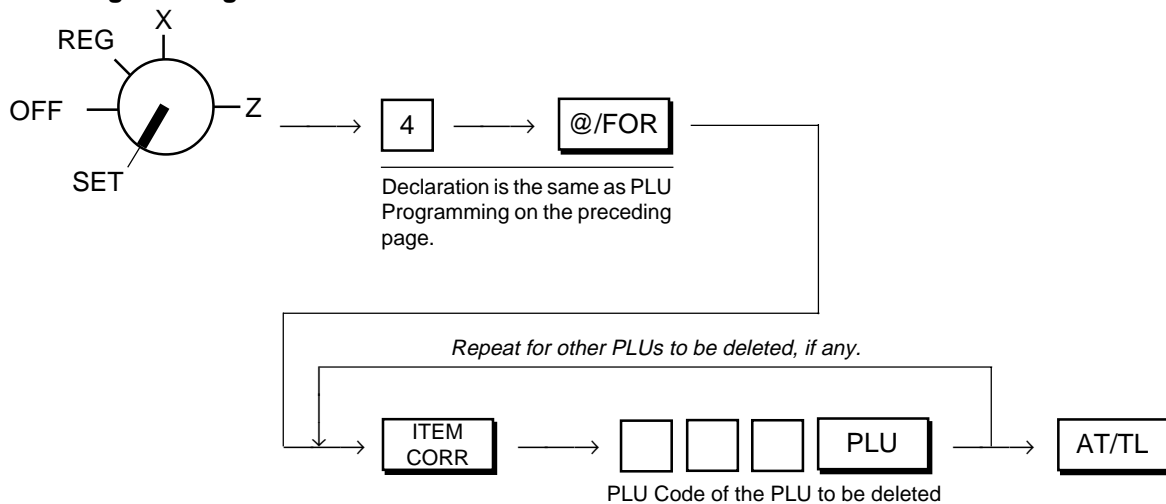

- NOTES:** 1. Deletions are possible PLU by PLU.
2. If all the PLUs must be deleted (i.e., the PLU system itself is not necessary), close the [PLU] Key. (Refer to Chapter "11. Optional Key Setting" on page 21.)

PLU Deletion Receipt Format:

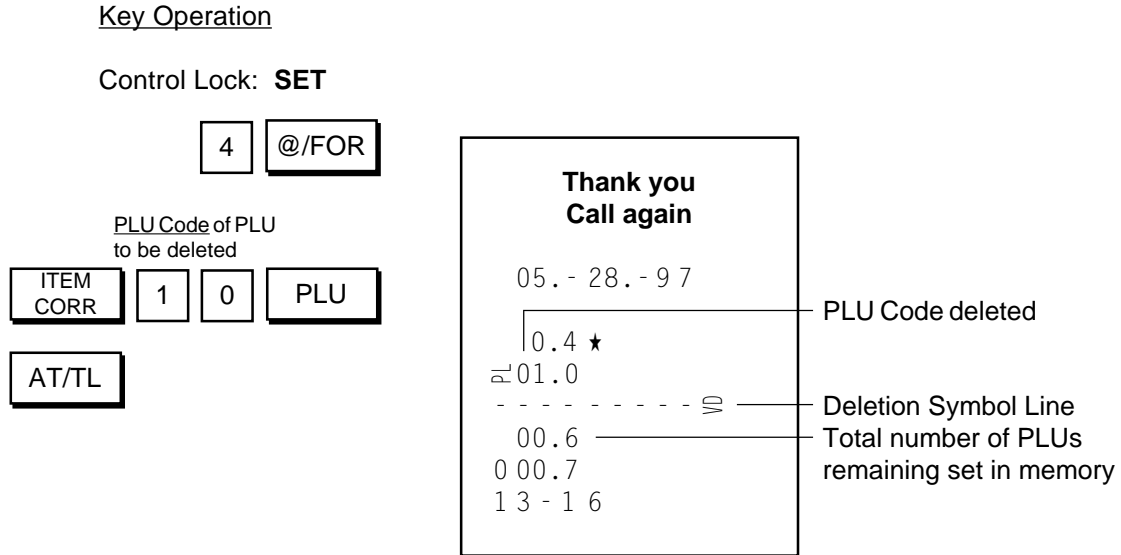

PLU Preset Price Changing:

When only changing preset prices of PLUs as part of daily requirements, this operation is quicker than operating "PLU Table Setting".

Condition: Any time outside a sale

Setting Procedure:

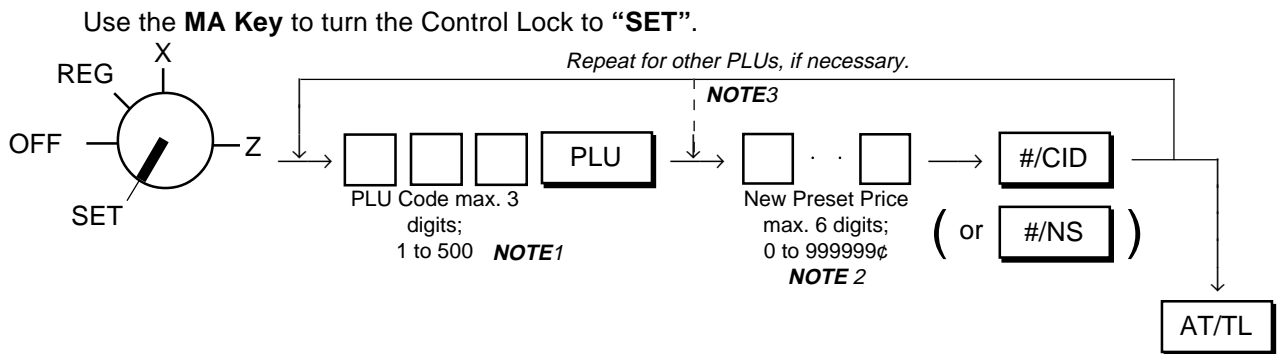

- NOTES:** 1. The PLU Code must exist in the PLU table file already programmed.
2. If "0" is entered as the New Preset Price, price of \$0.00 is set. Neither price setting nor changing is possible for Open-price PLUs in this operation.
3. For sequentially accessing PLU Codes, the code specification can be omitted.

PLU Price Change Setting Receipt Format:

Key Operation

Control Lock: **SET**

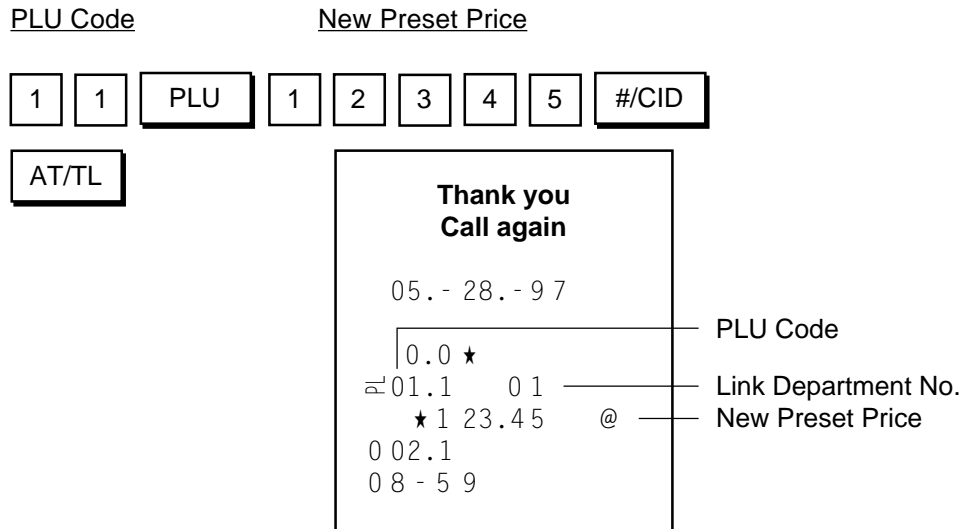

Sale Item Entries of PLUs

Various types of PLU entries are shown below.

Use the **REG** Key to turn the Control Lock to "REG".

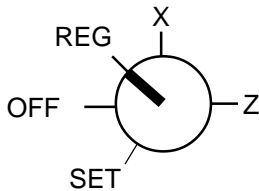

Entry of One Item

Preset-price PLU

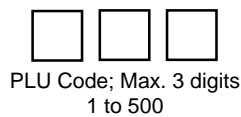

If an error occurs here:

Possible cause of error:

- Undefined PLU Code has been entered.
→ Enter a code of those PLUs programmed.

Open-price PLU

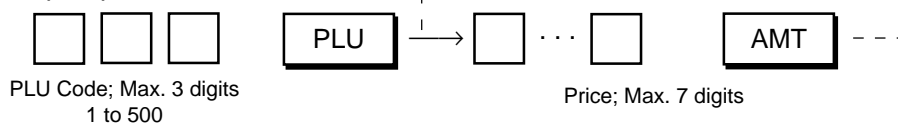

If an error occurs here:

Possible cause of error:

- Exceeding the price digit limit.
→ Check the Price.
- The PLU Code entered is a Preset-price PLU.
→ In that case the PLU item is already entered and printed on the [PLU] key depression. Check if the PLU Code and the price are correct.

Price Entered (When the price is within 3 digits, it is printed on the PLU Code line.)

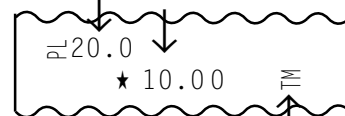

Status Symbol

- TM: Tax 1 or/and Tax 2 (PST) Taxable
- *: GST Taxable
- TM*: Tax (PST) Taxable and GST Taxable
- Blank: Non-taxable

Repeat Entry

Preset-price PLU

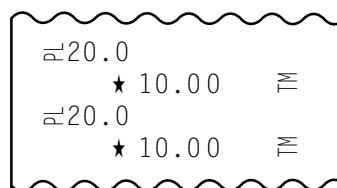
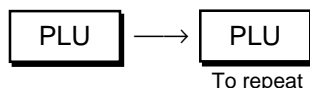
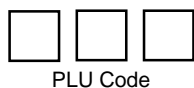

Open-price PLU

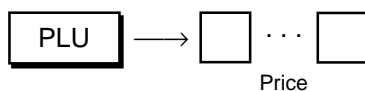
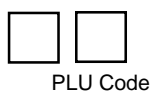

NOTE: A negative PLU entry cannot be repeated.

Quantity Extension (Multiplication)

Preset-price PLU

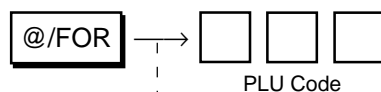
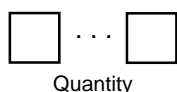

If an error occurs here:
Possible cause of error:
• Exceeding the digit limit

If an error occurs here:
Possible cause of error:
• Product exceeding 7 digits.
→ Check the Quantity.

Open-price PLU

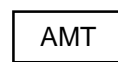
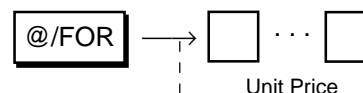
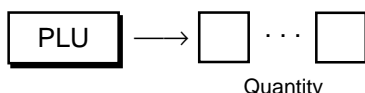

If an error occurs here:
Possible cause of error:
• Exceeding the digit limit

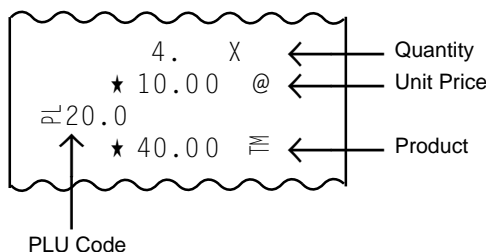

- NOTES:**
- Quantity... Max. 6 digits (Max. 3 digits for integer + max. 3 digits for decimal. Use the [.] key if a decimal portion is contained.)
Unit Price ... Max. 6 digits
Product (result of multiplication) ... Must not exceed 7 digits.
 - The decimal portion of the Quantity entry is processed down to the 2 digits below the decimal point. The fraction rounding at this time is fixed to ROUND OFF.
 - You can select the rounding process of the fractions of the product —ROUND OFF (initial setting), ROUND UP, or ROUND DOWN. (Refer to Chapter “16. System Option Setting, Address 2 - Bits 1 and 2” on page 72.)

If an error occurs here:
Possible cause of error:
• Exceeding the LC of the link Department
→ Check the Unit Price.
→ See **Listing Capacity Open**.
• Product exceeding 7 digits.
→ Check the Quantity and Unit Price.

Single-item PLU Entry

If a Department key is programmed with Single-item Status, an entry through a PLU which links to the Department immediately finalizes the sale as cash without operating a Media key. The operation is the same as ordinary Itemized PLU entries already described (Entry of One Item, Quantity Extension).

Thank you Call again		
05.- 28.- 97		
≡10.1	★3.40	
	★3.40	CA
0 10.7		
0 9 - 1 8		

Listing Capacity Open

LC OPEN

(Listing Capacity Open Key)

As for setting LCs, see “**Department LC (Listing Capacity) Programming**” on page 35 in the “**Department Keys**” section.

When an item entry price exceeds the Listing Capacity (programmed for each department) in sale entries, use the **[LC OPEN]** key to release the Listing Capacity. The Listing Capacity for the department or PLU will be exceeded with two higher digits for that entry only.

Depress

LC OPEN

 prior to or any time (before the final key at the latest) during the entry sequence of the following operations:

- Entry of One Department Item**
- Department Repeat Entry**
- Other Income Department**
- Department Quantity Extension**
- Department SPP**
- Single-item Department Entry**
- Entry of One PLU Item**
- PLU Repeat Entry**
- PLU Quantity Extension**
- Single-item PLU Entry**

Percent Charge, Percent Discount

% +

(% + Key)

% -

(% - Key)

These keys are used to add or subtract a percent rate to or from an individual sale entry item or the entire sale. Each of the keys can function with a rate manually entered or a preset rate. To activate the preset rate entry, rate setting is necessary.

% Key Preset Rate Setting or Changing

Condition: Any time outside a sale

Setting Procedure:

Use the **MA Key** to turn the Control Lock to **"SET"**.

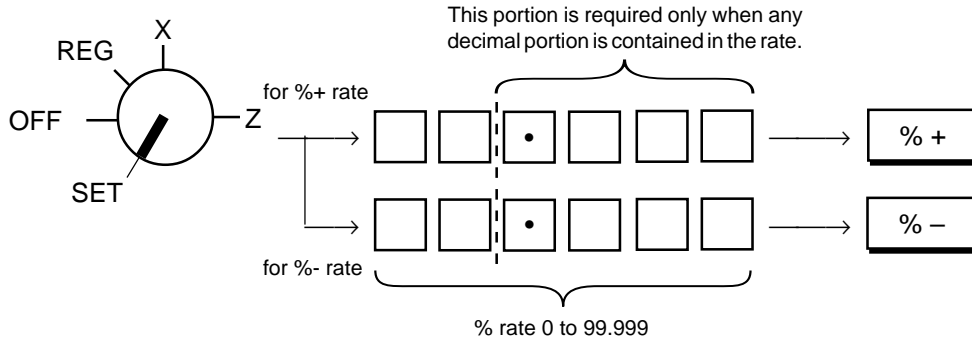

Examples)

7%:

7

12%:

1 2

8.55%:

8 • 5 5

12.345%:

1 2 • 3 4 5

To reset the rate once set:

0

When "0" is set, the % key will always require a manual rate entry to be operated in sale entries.

**Thank you
Call again**

05.- 28.- 9 7

0.0 ★

10. % +

0 01.3

0 8 - 5 4

%+ 10% is set.

**Thank you
Call again**

05.- 28.- 9 7

0.0 ★

5. % -

0 01.4

0 8 - 5 4

%- 5% is set.

% Key Operations in Sale Entries

Use the **REG** Key turn the Control Lock to “REG”.

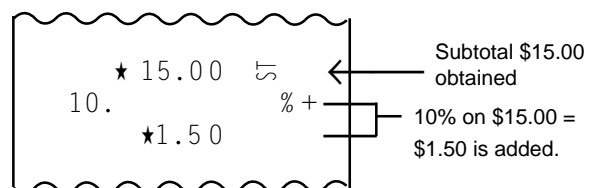
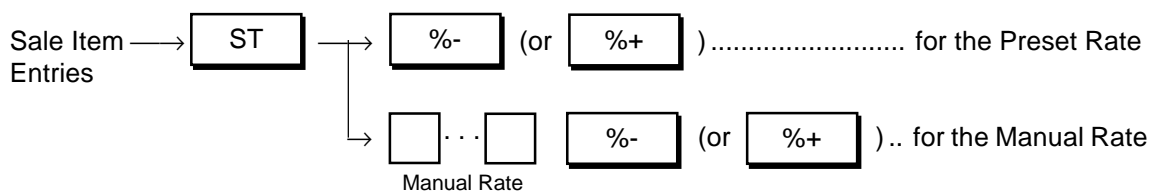
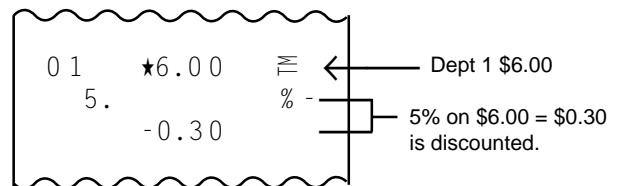
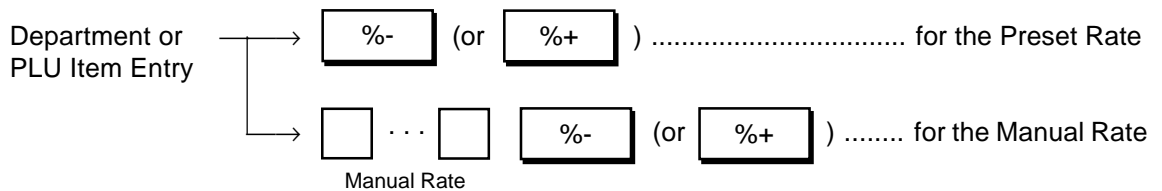
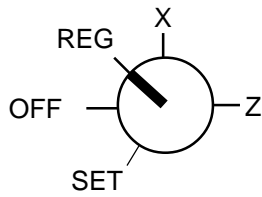

- NOTES:**
1. Manual Rate... Max. 5 digits (Max. 2 digits for integer + max. 3 digits for decimal. Use the [.] key if a decimal portion is contained.)
 2. When a rate is manually entered through a % key preset with a rate, the manual rate prevails.
 3. A % entry will cause an error if operated after a Negative Department or an Other Income Department entry.
 4. A % entry after obtaining a Subtotal is usually allowed only once. However, it can be programmed to allow multiple times. (Refer to Chapter “16. System Option Setting”, Address 16 - Bit 2 on page 81.)
 5. You can select the rounding process of the fractions of the product (result of % calculation) — ROUND OFF (initial setting), ROUND UP, or ROUND DOWN. (Refer to Chapter “16. System Option Setting”, Address 2 - Bits 1 and 2 on page 72.)
 6. Each of the % keys has its own Tax (PST) Status and GST Status programmed. Refer to “Tax Status Modification” on page 56 for reversing the status.

Dollar Discount DOLL
DISC (Dollar Discount Key)

Dollar Discount is used to subtract an amount from the sale total.

Use the **REG Key** to turn the Control Lock to “REG”.

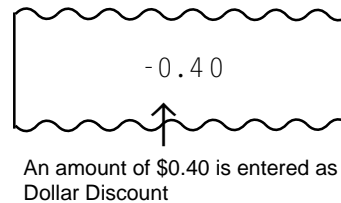
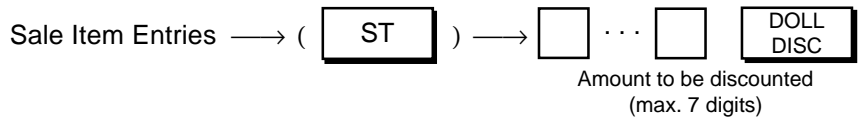
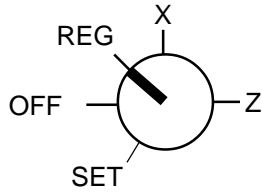

- NOTES:**
- For entering a Dollar Discount that will cause the sale total into negative (credit balance), refer to Chapter “16. System Option Setting”, Address 2 - Bit 3 on page 72:
 If status “Credit Balance Prohibited” (initial status) is selected:
 Over-subtraction of the sale total by Dollar Discount causes an error.
 If status “Credit Balance Allowed” is selected:
 Over-subtraction of the sale total by Dollar Discount is possible.
 - The **[DOLL DISC]** key has its own Tax (PST) Status and GST Status programmed. Also refer to “Tax Status Modification” on page 56 for reversing the status.

Item Correct (Last Line Voiding) ITEM
CORR (Item Correct Key)

The last line item (any of the following items that has just been entered within the current transaction) can be deleted by the **[ITEM CORR]** key.

- Entry of One Department Item
- Department Repeat Entry (*NOTE 1*)
- Other Income Department
- Department Quantity Extension (*NOTE 2*)
- Department SPP (*NOTE 2*)
- Entry of One PLU Item
- PLU Repeat Entry (*NOTE 1*)
- PLU Quantity Extension (*NOTE 2*)
- Percent Discount or Percent Charge
- Dollar Discount
- Received-on-Account Item
- Paid Out Item
- Manual Tax

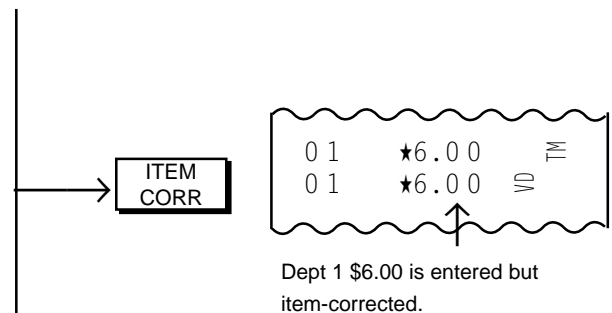

- NOTES:**
- When the **[ITEM CORR]** key is depressed after repeated items, only the last item of the repeated is deleted, decrementing the “RPT” count in the display.
 - When the **[ITEM CORR]** key is depressed after a Quantity Extension or Department SPP, the entire product (result of the calculation) is deleted.
 - Void, Returned Merchandise items cannot be deleted by the **[ITEM CORR]** key. Neither can any media amount be item-corrected even if it is short-tendered.

Void (Designated Line Voiding)

VOID (Void Key)

A Department or PLU item entered before the last item but canceled in the current sale (which can no longer be deleted by **[ITEM CORR]**) is entered as a Void item using the **[VOID]** key. If this key is not installed on your register, the **[RTN MDSE]** key may be used for voiding purposes (*refer to the next page*). If both **[VOID]** and **[RTN MDSE]** are installed, **[VOID]** should be used to cancel (delete) an item already entered within the current transaction while **[RTN MDSE]** should be used to record an item that was purchased in a past sale and is now returned.

Depress **VOID** prior to or any time during the entry sequence of the following operations:

- Entry of One Department Item
- Other Income Department
- Department Quantity Extension
- Department SPP
- Single-item Department Entry
- Entry of One PLU Item
- PLU Quantity Extension
- Single-item PLU Entry
- Percent Discount/Charge on a Department or PLU Item (*NOTE 1*)



"VD" ... Symbol of Void item

(Repeat entry is not possible using the **[VOID]** key.)

NOTES: 1. When an item previously entered with a Percent Discount or Percent Charge is canceled, the item can be voided with the Percent Discount/Charge by attaching the **[VOID]** key to the same entry procedure as previous entry.

At Entry



At Void

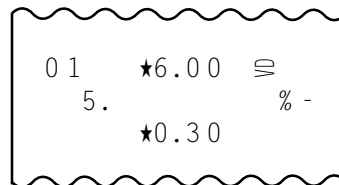

The process of the amount resulted from % calculation is reversed at Void.

2. The Void entries are usually possible only inside a sale. However, when the option "Credit Balance Allowed" is selected, they are allowed outside a sale as well and over-subtraction of the sale is also allowed. (Refer to Chapter "16. System Option Setting", Address 2 - Bit 3 on page 72.)
3. Neither Negative Department nor Negative PLU items can be entered as Void items.

All Void (Transaction Cancel) ALL VOID (All Void Key)

When some items have already been entered in the current sale and the customer cancels the entire contents of the sale, the **[ALL VOID]** key is used.

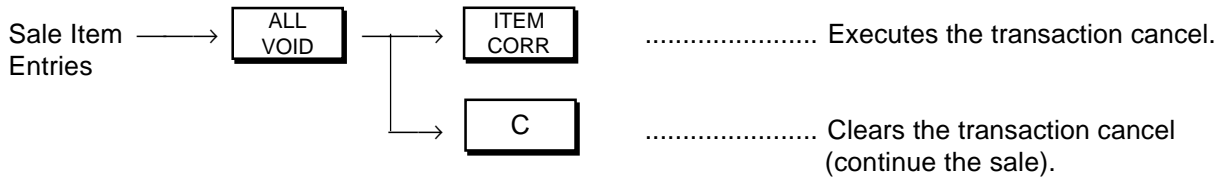

- NOTES:**
1. The All Void Operation is no longer acceptable when any media key (such as **[AT/TL]**) is entered including short-tendering.
 2. If Tax Exempt (using the **[EX]** key) is entered, the sale can no longer be all-voided.
 3. The All Void function is not effective for Received-on-Account or Paid Out transactions.
 4. When more than 20 items have been entered in the current sale, the All Void function is no longer effective.

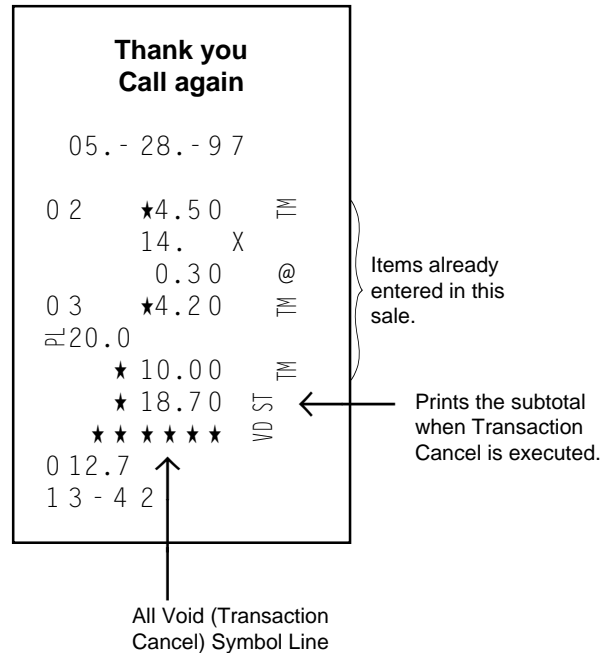

Returned Merchandise RTN MDSE (Returned Merchandise Key)

A Department or PLU item once purchased (i.e. the sale is already finalized) then returned by a customer can be entered as a Returned Merchandise item. If the **[VOID]** key is not installed on your register, this function may also be used as Void entry (refer to **Void entries on the preceding page**).

Depress RTN MDSE prior to or any time (before the final key at the latest) during the entry sequence of the following operations:

- Entry of One Department Item
- Other Income Department
- Department Quantity Extension
- Department SPP
- Single-item Department Entry
- Entry of One PLU Item
- PLU Quantity Extension
- Single-item PLU Entry
- Percent Discount/Charge on a Department or PLU Item (**NOTE 1**)

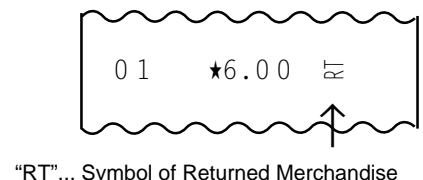

(Repeat entry is not possible using the **[RTN MDSE]** key.)

NOTES: 1. When an item once purchased with a Percent Discount or Percent Charge is returned, the item can be returned with the Percent Discount/Charge by attaching the **[RTN MDSE]** key to the same entry procedure as purchase.



The process of the amount resulted from % calculation is reversed at Return.

2. The Returned Merchandise entries are possible outside as well as inside a sale. Over-subtraction of the sale is allowed for Returned Merchandise entries.
3. Neither Negative Department nor Negative PLU items can be entered as Returned Merchandise.

Non-add Number Print

#/CID (Non-add Number Print/Cash-in-drawer Key)

#/NS (Non-add Number Prin/No-sale Key)

When any code number is to be recorded for future reference, such as a Check No., Customer No., Credit Card No., House Charge Account No., etc., a Non-add Number Print function is used.

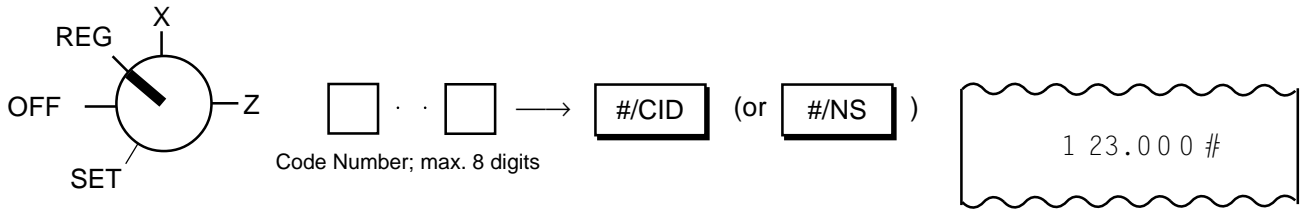

- NOTES:**
1. The preceding zeros, if any, will not be printed. For example, if "0123000" is entered, "123000" is printed.
 2. Usually, Non-add Number entries are prohibited at the starting of a No-sale transaction (i.e. Non-add Numbers cannot be printed on a No-sale receipt). However, a No-sale entry can be programmed to be allowable after a Non-add Number entry (refer to Chapter "16. System Option Setting", Address 15 - Bit 1 on page 80).
 3. The **[#/NS]** key operates and functions the same. When this key is simply depressed without a prior numeric entry in **REG** mode, it functions as the **[NS]** (No-sale) key. (Refer to the section of **No-sale Transaction** on page 29.)

Subtotal Read **ST** (Subtotal Key)

When the sale total of the current sale is to be read by the customer's request or the operator's requirement, the **[ST]** key is used.

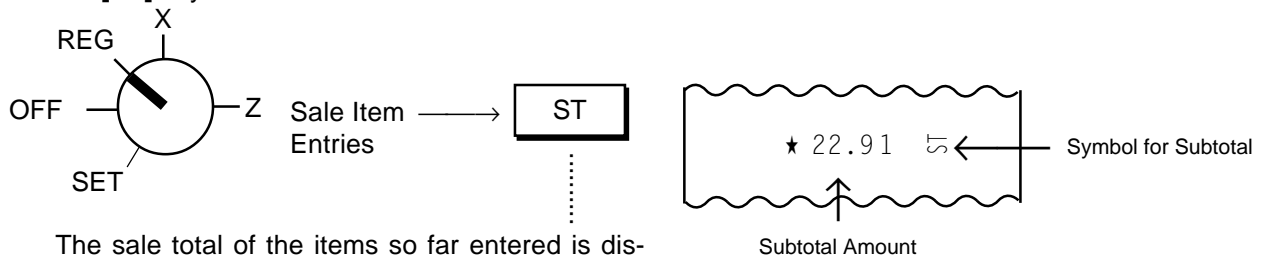

The sale total of the items so far entered is displayed in the AMOUNT portion with the "ST" triangular lamp illuminated. At the same time, the sale total is printed. The sale is not finalized yet.

- NOTES:**
1. When the **[ST]** key is depressed, the sale total is displayed and printed. However, you can select not to print (display only) by a system option. (Refer to Chapter "16. System Option Setting", Address 1 - Bit 3 on page 71.)
 Even if this non-print option is selected, the subtotal amount is automatically printed when a Percent Charge/Discount or Dollar Discount entry follows a subtotal entry.
 2. The displayed subtotal amount includes the taxes due (Tax 1, Tax 2, & GST) while the printed subtotal amount is the pre-taxed amount (amount not including taxes due). As for the displayed amount, you can select to display the pre-taxed amount by a system option. (Refer to Chapter "16. System Option Setting", Address 15 - Bit 4 on page 80.) This option is recommended only when both **[ST]** and **[TXBL TL]** (Taxable Total) keys are installed. In that case, **[ST]** displays pre-taxed amount while **[TXBL TL]** displays post-taxed amount (amount including taxes due).
 3. If the option "Taxable Total Compulsory" is selected with the function of subtotal display including taxes due (refer to NOTE 2 above), the **[ST]** key must always be depressed before operating media keys for finalizing a sale. (Refer to Chapter "16. System Option Setting", Address 2 - Bit 4 on page 72.)
 4. When the **[ST]** key is depressed more than once consecutively, the subtotal amount is only displayed but no print occurs from the second time on. If the **[C]** key is operated to clear a numeric entry or error, etc. after a subtotal is once obtained, the subtotal amount is again displayed.

Taxable Total Read **TXBL TL** (Taxable Total Key)

This key is used only to display the Taxable Total (sale total including taxes) during a sale. The key is usually not necessary since the **[ST]** key contains this function. If it is installed, however, it is recommended to program the **[ST]** key to display the pre-taxed amount (for distinguishing it from the **[TXBL TL]** key function). Refer to NOTE 2 attached to the section of "Subtotal Read" above.

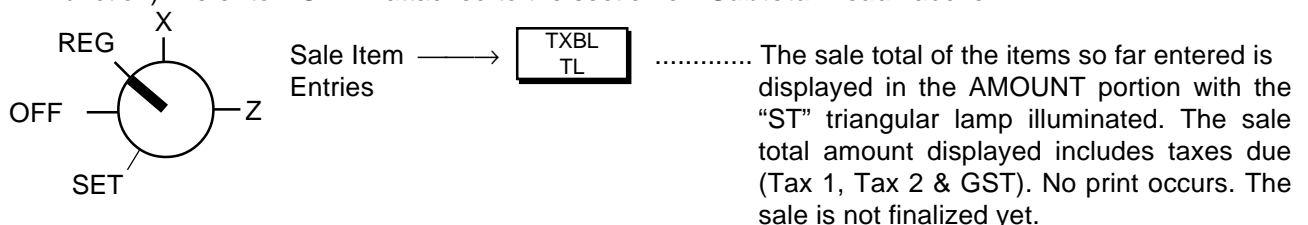

- NOTES:**
1. If the option "Taxable Total Compulsory" is selected, the **[TXBL TL]** key must always be depressed before operating media keys for finalizing a sale. (Refer to Chapter "16. System Option Setting", Address 2 - Bit 4 on page 72.)
 2. If the **[C]** key is operated to clear a numeric entry or error, etc. after a Taxable Total is once obtained, the Taxable Total amount is again displayed.

Manual Tax Entry TAX (Manual Tax Key)

This is an optional key, and used to enter an irregular tax amount.

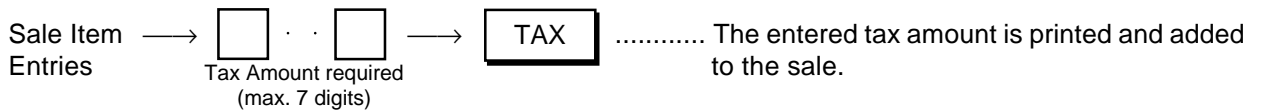

- NOTES:**
1. The amount entered through the **[TAX]** key is not included in the tax amount automatically calculated at sale finalization. The Manual Tax amount is separately added and is processed into the Manual Tax total (separately from Tax 1, Tax 2, and GST) in the report memory.
 2. A Manual Tax amount entered can be item-corrected, but cannot be deleted by **[VOID]** or **[RTN MDSE]**.

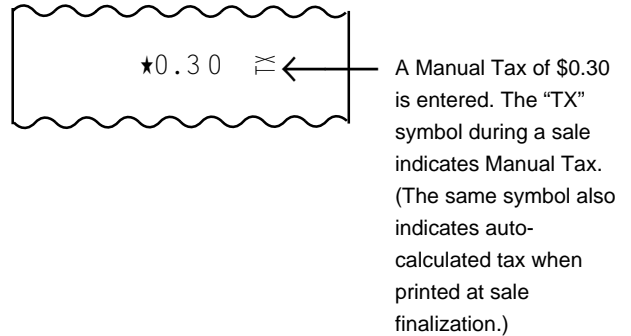

Finalizing a Sale AT/TL (Cash Amount Tender/Total Key), CHK TND (Check Tender Key), Chg (Charge Total Key)

These keys are used to finalize a sale after entering all sales items.

1) Media Total

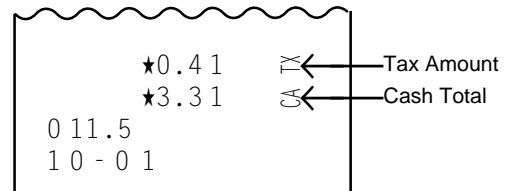
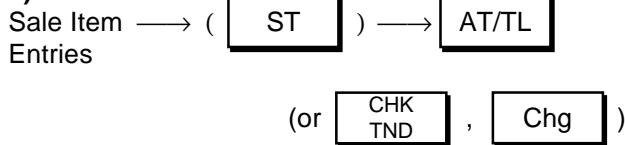

2) Media Tender

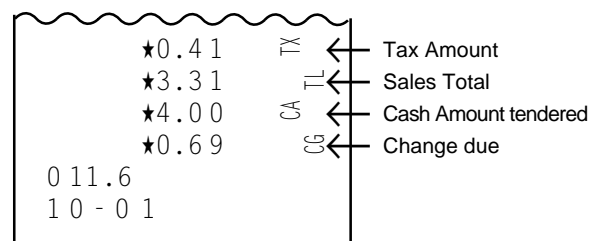
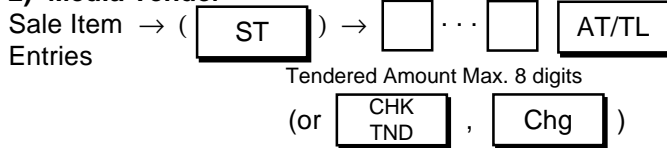

3) Multi-Tender (short- tender repeated by the same media)

Example)

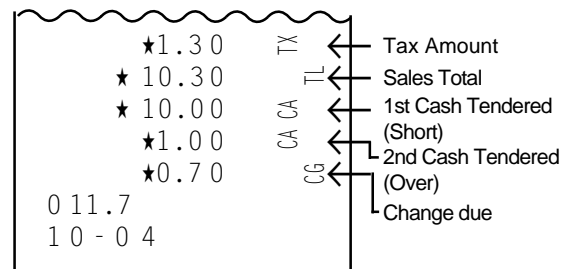
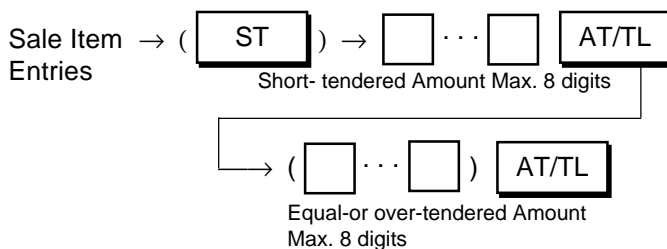

4) Split-Tender (short- tender repeated by the different media)

Example)

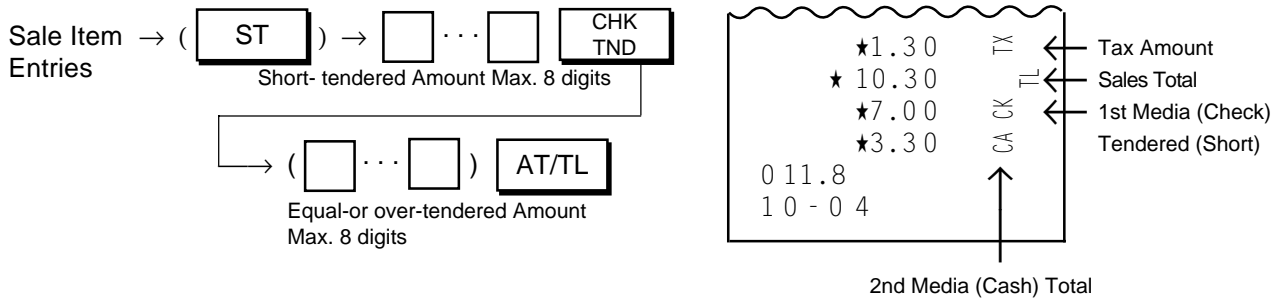

- NOTES:**
1. Each Media key is programmed as follows as standard. (Refer to Chapter "16. System Option Setting", Addresses 6 to 8 on pages 74 to 76.)
[AT/TL]...Tender/Total, [CHK TND]...Tender only, [Chg]...Total only
 2. When the option "Taxable Total Compulsory" is selected, the sale is finalized only after reading the sale total (by [ST] or [TXBL TL]). (Refer to Chapter "16. System Option Setting", Address 2 - Bit 4 on page 72.)
 3. When the option "Short-tendering Prohibited" is selected, short-tendering is not possible. (Refer to Chapter "16. System Option Setting", Address 11 -Bit 1 on page 77.)

Check Cashing (Cashing Non-cash Media)

<operable outside a sale only>

[CHK TND] (Check Tender)

[Chg] (Charge Total Key)

Check cashing (cashing non-cash media) requested by a customer is entered through a non-cash media key. It is operable only outside a sale (i.e. when no sale is underway on the register).

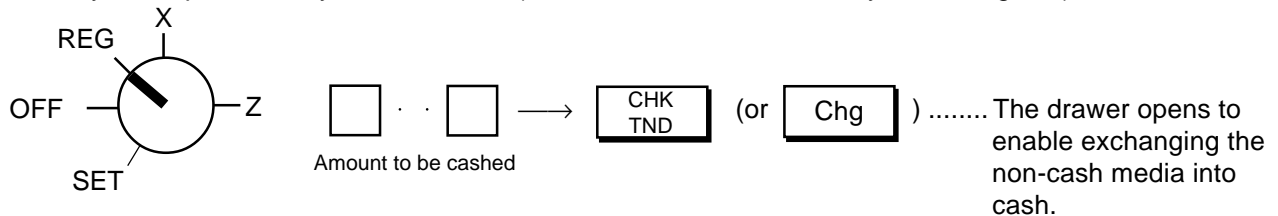

NOTE: The [CHK TND] key is programmed to allow cashing as initial status. It can be programmed to prohibit cashing. (Refer to Chapter "16. System Option Setting", Address 7 - Bit 3 on page 75.) Similarly, cashing using the [Chg] key is programmed to prohibit cashing as initial status. It can be programmed to allow cashing. (Refer to Chapter "16. System Option Setting", Address 8 - Bit 3 on page 76.)

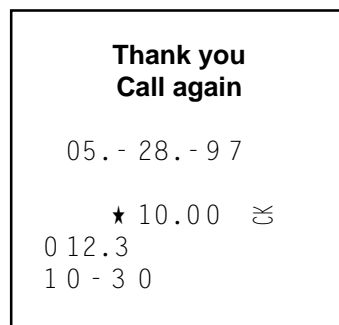

Post-issue Receipt

[RECEIPT ISSUE] (Post-issue Receipt Key)

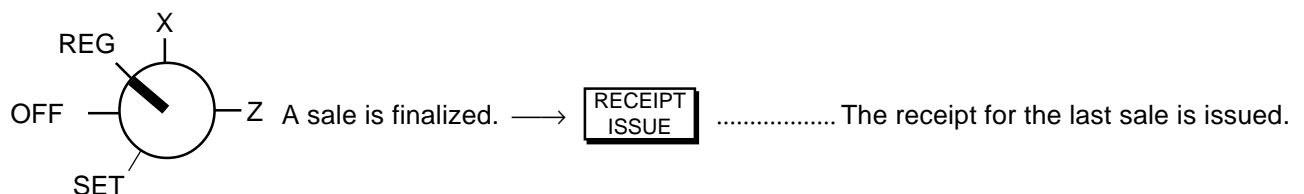

- NOTES:**
1. The Post-issue Receipt function is effective only when the Receipt-format Option has been selected.
 2. When a sale has contents of 20 print lines or less, the post-issue receipt will be an itemized receipt, just as the ordinary receipt. When it has more than 20 print lines, the post-issue receipt will be a total-only receipt.
 3. The Post-issue receipt function is not effective for Received-on-Account, Paid Out, or All Void transaction.
 4. If a Non-add Number print is entered at the top of a sale, the number will not be printed on the Post-issue Receipt.
 5. The Post-issue Receipt function is available regardless of "R OFF" lamp status. (Refer to "Receipt-issue/Non-issue Selection" in this chapter for the detailed description of "R OFF" lamp status.)

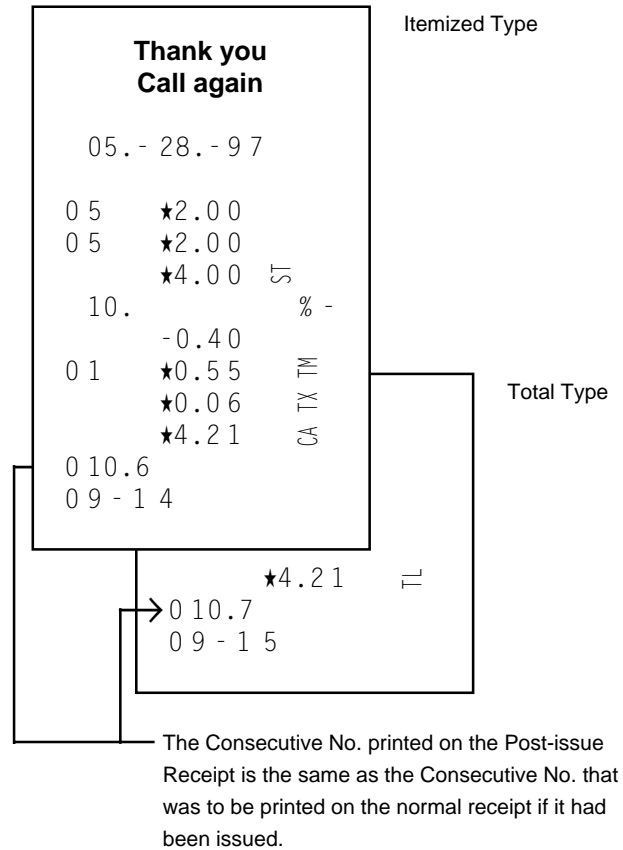

Tax Status Modification

TX/M (or **TX1/M**), Tax (PST) 1 Modifier Key

TX2/M Tax (PST) 2 Modifier Key

GST/M GST Modifier Key

Each of these keys is used to reverse the tax status of a required Department or PLU item to be entered in a sale. It is also used to reverse the Non-taxable status of [% +], [% -], and [DOLL DISC] keys into Taxable status. The Modifier Keys are effective only for one entry.

Depress the required modifier key(s) (**TX1/M**, **TX2/M**, **GST/M**) prior to or any time (before the final key at the latest) during the entry sequence of the following operations. More than one modifier keys can be depressed for the same item entry.

- Entry of One Department Item
- Department Repeat Entry
- Other Income Department
- Department Quantity Extension
- Department SPP
- Single-item Department Entry
- Entry of One PLU Item
- PLU Repeat Entry
- PLU Quantity Extension
- Single-item Department Entry

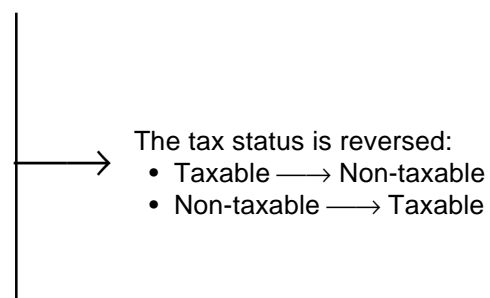

Percent Charge
Percent Discount
Dollar Discount

The Tax Status of each key (refer to Chapter "16. System Option Setting", Address 3 and supplementary descriptions on page 73) is reversed:

- Taxable → Non-taxable
- Non-taxable → Taxable

Tax Exemption [EX] (Tax Exempt Key)

When an entire sale must be exempted from designated or all taxes (Tax/PST 1, Tax/PST 2, GST), the [EX] key is used near the end of the sale finalization. (To exempt an individual item from designated taxes, only Tax Modifier Keys are used in entering the item. Refer to the section "Tax Status Modification" on the preceding page.)

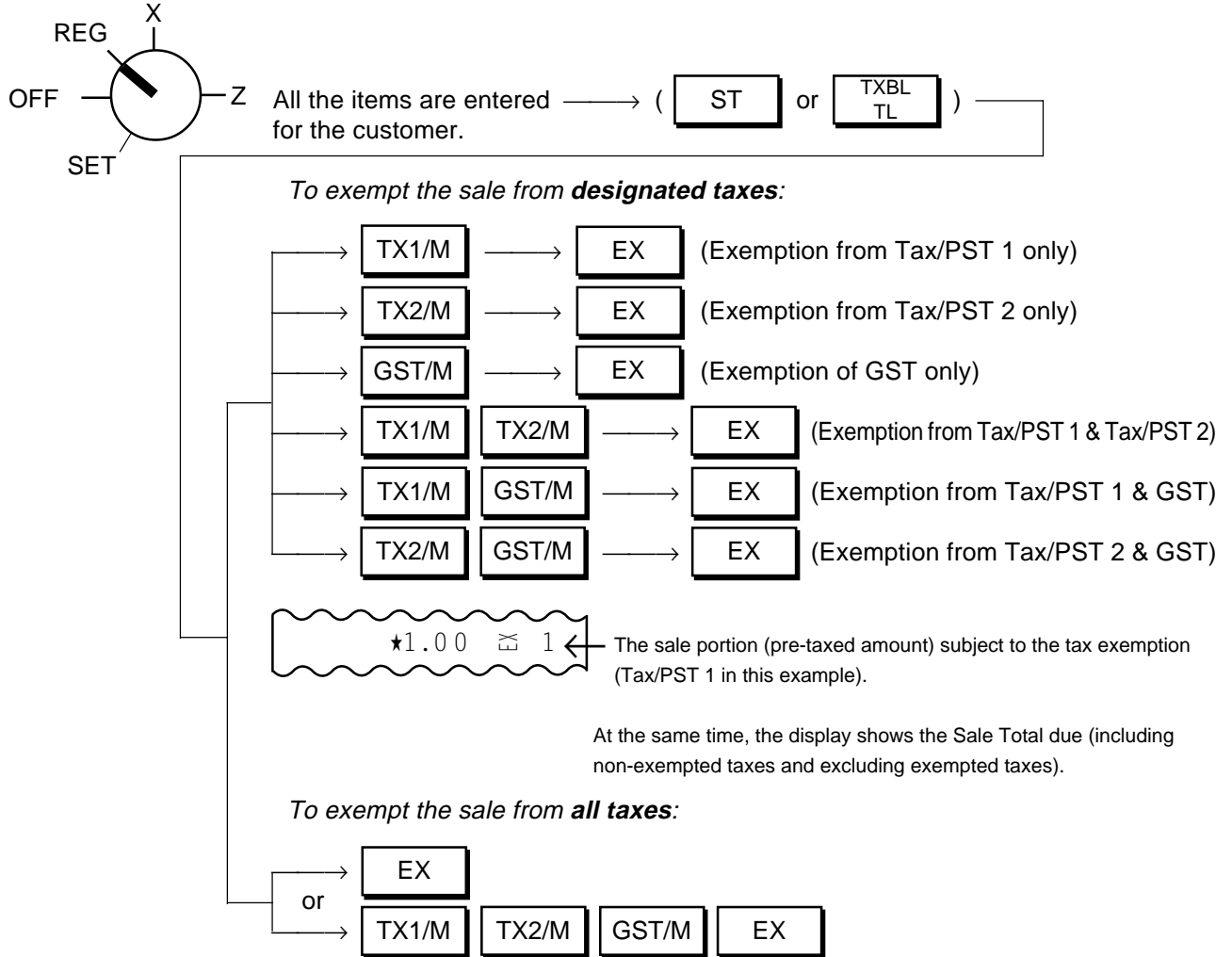

- NOTES:**
1. The Tax Exempt entry cannot be item-corrected.
 2. After depressing the [EX] key, the sale must only be finalized (for payment through media keys).
 3. If the "Non-taxable Amount Limit" is set for certain areas in Canada, using the [GST/M] key will cause an error and GST Exemption is not allowed.

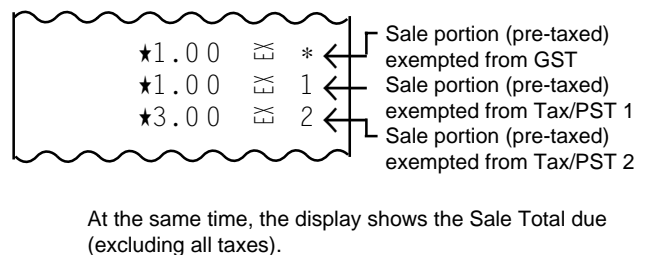

Print/Non-print Options on Sale Receipts

The following are items that can be programmed to be printed or not on sale receipts.
To change the print/non-print status, refer to Chapter "16. System Option Setting" on page 69. For changing the print/non-print status of each item, further refer to the **Address No.** and **Bit No.** in the chapter.

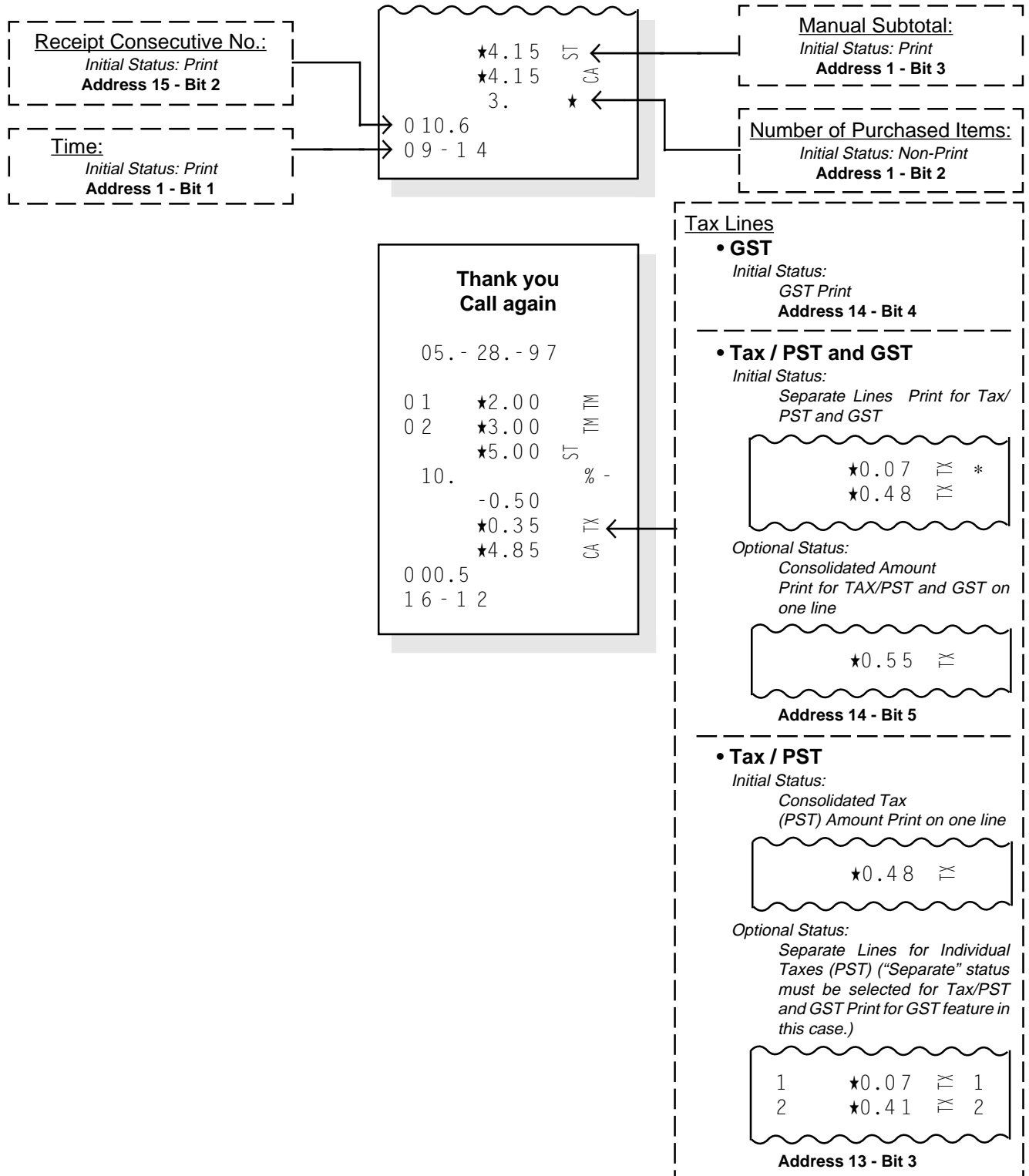

15. Read and Reset Reports

This chapter describes the operation to take each report and its contents. The report function is one of the most beneficial features of this register. As sales data are entered, the register processes the data into appropriate totals and counters in the report memory. The reports are not only a form of sales data records but will also be a valuable guide to a more prosperous future of your store if you fully utilize and analyze them.

Programming Operations Relating to Reports

Programming Hourly Range Table

The "Hourly Sales Report" is available as part of the report function. However, sales data entered in REG mode are processed into Hourly Ranges only after programming an Hourly Range Table. If you have started operations on the register without this programming operation performed, the "Hourly Sales Report" cannot be taken (an error will result on attempt to take this report). The Hourly Sales Report table must be programmed in order to obtain Hourly Sales Reports during operations.

Condition: After Hourly Sales Reset
 (refer to "NOTE on Condition" on page 15)

Programming Procedure:

Use the **MA Key** to turn the Control Lock to "SET".

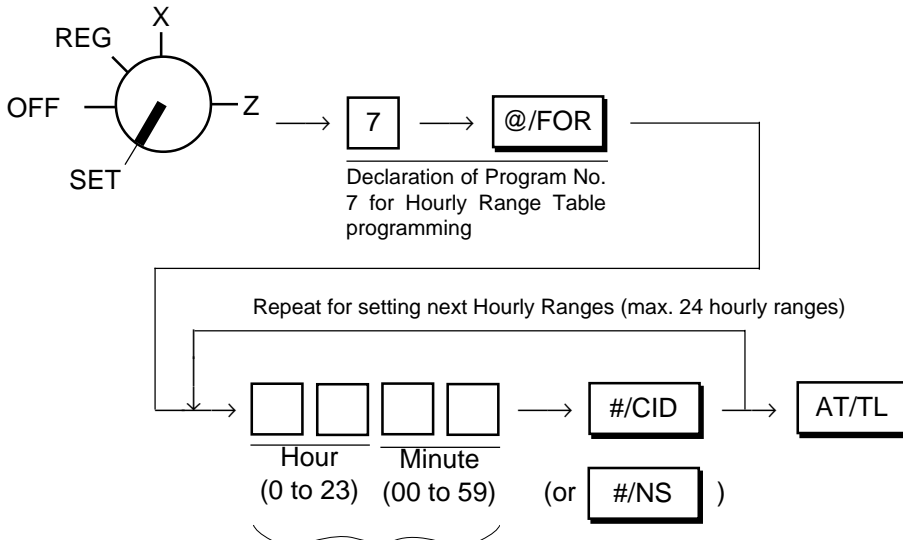

Enter the time that ends the Hourly Range, in the 24-hour system using the military time. (The time to start is the time entered for the preceding Hourly Range.) (See NOTES 2, 3)

- NOTES:**
1. A maximum of 24 hourly ranges may be set.
 2. Do not set an hourly range across 24:00, such as "from 23:00 to 1:00". Such setting does not cause an error in programming but the sales data will not be processed into that hourly range.
 3. If an hourly value of more than 23 or a minute value of more than 59 is set, it will not result in an error but the data will not be processed into that hourly range.
 4. To change the table of hourly ranges once set, partially or entirely, do the entire setting operation over again.
 5. To clear the hourly range table once set, operate in **SET** mode:

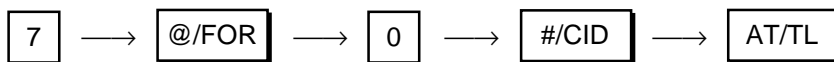

Programming Example:

Hourly Range Table

up to 8:00
8:00 to 9:00
9:00 to 10:00
10:00 to 13:00
13:00 to 16:30
16:30 to 18:00

Key Operation

Control Lock: **SET**

7 @/FOR

8 0 0 #/CID

9 0 0 #/CID

1 0 0 0 #/CID

1 3 0 0 #/CID

1 6 3 0 #/CID

1 8 0 0 #/CID

AT/TL

**Thank you
Call again**

05.- 28.- 97

0.7 ★

08 - 00

09 - 00

10 - 00

13 - 00

16 - 30

18 - 00

001.0

08 - 51

Selecting Print/Non-print Items on Reports

The following table shows the items on reports that can be programmed to be printed or non-printed according to your store's requirements. For further details of programming, refer to Chapter "16. System Option Setting" on page 69. If you have started operations on the register without this programming operation performed, print or non-print status of each item is determined by the "Initial Status" in the following table. It is recommended, therefore, to change Print/Non-print status of each item after once taking all the reports.

Item	Initial Status Before Change	System Option Address No. - Bit No.	Page
GT (Grand Total)	Print	Address 1 - Bit 4	71
Sum of Negative Departments	Non-Print	Address 1 - Bit 6	
Sum of All Departments (except Other Income Depts)	Non-Print	Address 11 - Bit 2	77
Sum of Other Income Departments	Non-Print	Address 11 - Bit 3	
Net Sale With Taxes	Print	Address 13 - Bit 1	78
Net Sale Without Taxes	Non-Print	Address 13 - Bit 2	
Receipt Consecutive No. on Journal and every Receipt	Print	Address 15 - Bit 2	80
Receipt Consecutive No. Resetting	Non-resettable	Address 15 - Bit 3	

Taking Read and Reset Reports

Fundamental Concepts of Various Types of Reports

Four types of Reports are available in connection with the Control Lock positions and the periods of data accumulation:

- Daily Read Report:** It can be issued at any time and any number of times during the day. It allows to read the sales data recorded up to the moment since the corresponding Reset Report was issued yesterday. Taking this type of report will not affect any sales data in the report memory.
- Daily Reset Report:** The contents and format are the same as the Daily Read Report. However, it should be issued only once at the end of the day usually after closing the store. It is the “final” report that should be kept in file. Taking this type of report will clear all the resettable totals and counters in the report memory after the report is issued.
- Periodical Read Report:** It can be issued at any time and any number of times during a certain period defined by the store (one week, one month, etc.). Thus it allows to read the sales data accumulated up to the moment since the corresponding Reset Report was issued last time.
- Periodical Reset Report:** The contents and format are the same as the Periodical Read Report. However, it should be issued only once at the end of the defined period as the “final” report and be kept in file. Taking this type of report will clear all the resettable totals and counters in the report memory after the report is issued.

In addition, Read Reports (Daily or Periodical) are called “X” reports since the reports are taken with the Control Lock positioned to “X” and the header “X” is printed. Reset Reports (Daily or Periodical) are called “Z” reports, taken with the Control Lock positioned to “Z”, printing the header “Z”. Please also note the Reset Report Counter is printed on each Reset (Z) Report only. By this counter, you are sure that no illegal Reset Reports were taken between the one taken at the end of yesterday and the one taken now.

CAUTION : *Whenever you turn the Control Lock to “Z” position, be sure that you are taking Reset Reports (final reports) and that the sales data will be cleared by the operation to follow.*

WARNING!

When opening the cash drawer, be careful not to let the drawer hit any person.

Report Taking Operation

Before taking a report, be certain to confirm that the “R OFF” lamp is extinguished when the Receipt-format option has been selected. If it is illuminated, press the **[LOG/RECEIPT]** key to extinguish the lamp.

Daily Reports:

Report Name	Key Operation	Sample Page
* Financial Read * Financial Reset (NOTE 2)	Control Lock: X → <input type="checkbox"/> → <input type="checkbox"/> AT/TL Control Lock: Z → <input type="checkbox"/> → <input type="checkbox"/> AT/TL	63
Hourly Sales Read Hourly Sales Reset	Control Lock: X → <input type="checkbox"/> → <input type="checkbox"/> 1 0 AT/TL Control Lock: Z → <input type="checkbox"/> → <input type="checkbox"/> 1 0 AT/TL	66
All PLU Sales Read All PLU Sales Reset	Control Lock: X → <input type="checkbox"/> → <input type="checkbox"/> PLU Control Lock: Z → <input type="checkbox"/> → <input type="checkbox"/> PLU	66
Zone PLU Sales Read Zone PLU Sales Reset	Control Lock: X → <input type="checkbox"/> → <input type="checkbox"/> @/FOR <input type="checkbox"/> → <input type="checkbox"/> PLU Control Lock: Z → <input type="checkbox"/> → <input type="checkbox"/> @/FOR <input type="checkbox"/> → <input type="checkbox"/> PLU Zone-start PLU Code Zone-end PLU Code	66
* Media Sales and In-drawer Read	Control Lock: X → <input type="checkbox"/> → <input type="checkbox"/> #/CID (or <input type="checkbox"/> #/NS)	67
* Individual Cashier Read (NOTE 3) * Individual Cashier Reset (NOTE 3)	Control Lock: X → <input type="checkbox"/> → <input type="checkbox"/> LOG RECEIPT Control Lock: Z → <input type="checkbox"/> → <input type="checkbox"/> LOG RECEIPT Cashier Code: 1 to 8	67
Individual Department Read	Control Lock: X → <input type="checkbox"/> → (<input type="checkbox"/> DPT SHIFT) Dept. → <input type="checkbox"/> AT/TL Repeatable for another department	68

Periodical Reports:

Report Name	Key Operation	Sample Page
* Financial Read * Financial Reset	Control Lock: X → <input type="checkbox"/> → <input type="checkbox"/> 2 0 AT/TL Control Lock: Z → <input type="checkbox"/> → <input type="checkbox"/> 2 0 AT/TL	63
* All Cashier Read (NOTE 3) * All Cashier Reset (NOTE 3)	Control Lock: X → <input type="checkbox"/> → <input type="checkbox"/> 4 AT/TL Control Lock: Z → <input type="checkbox"/> → <input type="checkbox"/> 4 AT/TL	68

- NOTES:**
1. The cash drawer will open on the final key of the key operation for the reports marked with "*".
 2. If "Electronic Journal" option is selected (refer to "**Chapter 16. System Option Setting**", **Address 11-Bit 6** on page 77), the journal data will automatically printed after printing Financial Reset Report. Also, refer to **Chapter 18** on page 83.
 3. Cashier Read and Reset Reports can be issued when the Cashier Signing Option is selected. (refer to Chapter "**16. System Option Setting**", **Address 2-Bit 8** on page 72) Also, refer to **Chapter 17** on page 82.

Report Sample Format:

On the following pages are sample formats of respective reports. In referring to those formats, please note the following conditions:

- In each report format, all the items that can be programmed to print are placed.
- The data contents are merely examples to show the report format. The numeric data may not balance correctly. (Refer to the "**Memory Balance**" attached to the Daily Financial Read or Reset Report.)

Financial Read or Reset Report (Daily or Periodical)

**Thank you
Call again**

05.- 28.- 97

Z

★ 13.4 05.71 6

5 06. 8

★ 13.4 05.71 8

0 1 1 0 8

21.

★ 42.75

0 2 4 8

63.

★ 31.06

0 3 8 8

3 84.

★ 12.0 75.50

0 4 2 8

2.

-2.00

0 5 1 8

3.

★ 1.50

0 6 0 8

0.

★ 0.00

0 7 1 8

1.

★ 10.00

0 8 0 8

0.

★ 0.00

0 9 1 8

4.

- 12.00

1 0 0 8

0.

★ 0.00

Date

Report Type Symbol

X: Daily Read
Z: Daily Reset
20X: Periodical Read
20Z: Periodical Reset

Grand Total (*non-resettable*) (*Initial Status: Print*)

Gross Sale: Item Count
Amount

Dept. 1 Sales: Customer Count
Item Count
Amount

Dept. 2 Sales: Customer Count
Item Count
Amount

Dept. 3 Sales: Customer Count
Item Count
Amount

Dept. 4 Sales: Customer Count
Item Count
Amount

Dept. 5 Sales: Customer Count
Item Count
Amount

Dept. 6 Sales: Customer Count
Item Count
Amount

Dept. 7 Sales: Customer Count
Item Count
Amount

Dept. 8 Sales: Customer Count
Item Count
Amount

Dept. 9 Sales: Customer Count
Item Count
Amount

Dept.10 Sales: Customer Count
Item Count
Amount

4 0 0 8 @

0. @

★ 0.00 @

4 72. TL

★ 12.1 46.81 TL

1 % +

★ 0.95 % +

4 72. MS

★ 12.1 47.76 MS

★ 0.00 TX MS *

Dept.40 Customer Count
(Other Income Item Count
Dept.) Sales : Amount

Sum of Departments: Item Count
Amount (*Initial Status: Non-print*)

Percent Charge: Count
Amount

Net Sale Without Tax: Item Count
Amount (*Initial Status: Non-print*)

GST Amount

★1.2	06.90	TX	1	Tax (PST) 1 Amount	
★2.5		TX	2	Tax (PST) 2 Amount	
★0.00		TX	3	Tax 3 (Manual Tax) Amount	
4	72.	NS		Net Sale With Tax: Item Count	<input type="checkbox"/> (Initial Status: Print)
★13.3	57.19	NS		Amount	
0.		@		Sum of Other Income Depts.: Item Count	<input type="checkbox"/> (Initial Status: Non-print)
★0.00		@		Amount	
1	% -	% -		Percent Discount on Subtotal: Count	
★0.40		% -		Amount	
1	-	-		Dollar Discount: Count	
★0.40		-		Amount	
1	9	CU		Total Customer Count	
★13.3	56.39	CU	TL	All Media Sales Amount	
1	6	CU		Cash Sales: Customer Count	
★13.3	40.82	CU	CA	Amount	
1		CU	CA	Check Sales: Customer Count	
★7.2	6	CU	CK	Amount	
2		CU	CK	Charge Sales: Customer Count	
★8.3	1	CH		Amount	
2		CH	RA	Received-on-Account: Count	
★12.5	0	PO	RA	Amount	
3		PO	RA	Paid Out: Count	
★6.5	0	PO		Amount	
★13.3	43.58	ID		Cash-in-drawer Amount	
2		CK		Check Count	These items are printed on Daily Reports only but not on Periodical Reports.
★10.5	0	ID		Check-in-drawer Amount	
2		CH		Charge Count	
★8.3	1	ID		Charge-in-drawer Amount	
2		VD		Item Correct: Count	
★3.0	3	VD		Amount	
2		VD	2	Void: Count	
★11.0	0	VD	2	Amount	
1		VD	3	Misc. Void: Count	<input type="checkbox"/> (Item Correct and Void on other items than departments and PLUs)
★0.1	5	VD	3	Amount	
1		VD	4	All Void: Count	
★18.7	0	VD	4	Amount	
1	% -	% -		Percent Discount on Item: Count	
★0.3	2	% -		Amount	
6.				Sum of Negative Departments: Item Count	<input type="checkbox"/> (Initial Status: Non-print)
-14.0	0			Amount	
5.		RT		Returned Merchandise: Item Count	
★1.3	0	RT		Amount	
★0.1	7	TX	-	Negative or Returned Tax Amount	
★0.0	0	TT	*	Total of Sale Amount subject to GST	
1					
★12.0	69.02	TT		Total of Sale Amount subject to Tax (PST) 1	
2					
★50.5	0	TT		Total of Sale Amount subject to Tax (PST) 2	
1		EX		Total Tax Exempt Customer Count	
★0.0	0	EX	*	GST Exempt Amount	
★5.0	0	EX	1	Tax (PST) 1 Exempt Amount	
★5.0	0	EX	2	Tax (PST) 2 Exempt Amount	
1				No-sale Count	
00.0	01	Z		Reset Count of Financial Reset Report (printed on Reset Reports only)	
0	20.7			Receipt Consecutive No.	
1	3 - 5			Current Time	

- Memory Balance -

Grand Total	=	Sum of Daily Gross Sales
Gross Sale	=	(Sum of Depts) + (Sum of Tax/PST 1 & 2) + (Percent Charge) NOTE below + (Percent Discount on Item) + (Sum of Negative Depts) + (Item Correct) + (Void) + (Returned Merchandise) + (Negative Tax) + (GST) + (All Void)
Net Sale with Tax	=	(Sum of Depts) + (Sum of Tax/PST 1 & 2) + (Percent Charge) + (GST) NOTE below = (Gross Sale) - (Percent Discount on Item) + (Sum of Negative Depts) - (Item Correct) - (Void) - (Returned Merchandise) - (Negative Tax) - (All Void)
All Media Sales	=	(Net Sale With Tax) - (Percent Discount on Subtotal) - (Dollar Discount) + (Sum of Other Income Depts) = (Cash Sales) + (Check Sales) + (Charge Sales)
Sum of All Hourly Range Sales	=	Net Sale With Tax

NOTE: (Sum of Depts) = (Sum of Positive Depts) + (Sum of Negative Depts)
* Not includes Other Income Depts.

Daily Hourly Sales Read or Reset Report

```

Thank you
Call again

05.- 28.- 9 7
          1 0 Z
★ ★
08 - 0 0
09 - 0 0
          9 ☹
★ 69.18
10 - 0 0
          7 ☹
★ 48.66
13 - 0 0
16 - 3 0
18 - 0 0
          00.01 Z
004.8
13 - 4 3
    
```

Report Type Symbol { 10X: Daily Read
10Z: Daily Reset

Sales Data in Hourly Range from 18:00 yesterday to 8:00...No sales recorded
 Sales Data in Hourly Range from 8:00 to 9:00...No sales recorded
 Customer Count Net Sales Sales Data in Hourly Range from 9:00 to 10:00
 Customer Count Net Sales Sales Data in Hourly Range from 10:00 to 13:00
 Sales Data in Hourly Range from 13:00 to 16:30...No sales recorded
 Sales Data in Hourly Range from 16:30 to 18:00...No sales recorded
 Reset Count of Hourly Sales Reset Report (printed on Reset Reports only)

Daily PLU Read or Reset Report (All or Zone)

Daily All PLU Read or Reset Report

```

Thank you
Call again

05.- 28.- 9 7
          Z
☺ 05.0
          2.
★ 1.00
☺ 06.0
          4.
          - 12.00
☺ 07.0
          3.
★ 6.00
☺ 19.9
          4.
★ 40.00
          9.
★ 35.00
          00.01 Z
004.5
13 - 3 0
    
```

Report Type Symbol { X: Daily Read
Z: Daily Reset

PLU Code 50 (disregard the decimal point in the code):
 Sales Item Count
 Sales Amount
 PLU Code 60:
 Sales Item Count
 Sales Amount
 PLU Code 70:
 Sales Item Count
 Sales Amount
 PLU Code 199:
 Sales Item Count
 Sales Amount
 Total of all PLUs: Sales Item Count (Positive PLUs only)
 Amount (Positive PLUs-Negative PLUs)
 Reset Count of PLU Reset Report (including Zone Reset): *printed on Reset Reports only*

Daily Zone PLU Read or Reset Report

The format is the same as "All PLU Read or Reset Report" above. The only difference is that the **Zone Read or Reset Report** outputs only the PLUs in the zone designated by the key operation to take the report.

Daily Media Sales & In-drawer Read Report

```

    Thank you
    Call again

    05.-28.-97

                X
            1 6 00
    ★ 1 17.84
    ★ 1 05.93
                2 00
    ★ 10.50
                2 00
            ★ 7.41
    0 04.7
    1 3 - 4 2
    
```

Report Type Symbol (Daily Read Report only)
 Total Customer Count
 All Media Sales Amount
 Cash-in-drawer Amount
 Check Count
 Check-in-drawer Amount
 Charge Count
 Charge-in-drawer amount

Cashier Read or Reset Report (Daily or Periodical)

Daily Cashier Read or Reset Report

```

    Thank you
    Call again

    05.-28.-97

                Z
    ★ ★      2 00
                5 00
            13.
    ★ 57.50
            0.
    ★ 0.00
            00.01 Z
    0 04.9
    1 3 - 4 3
    
```

Report Type Symbol ———— { X: Daily Read
 Z: Daily Reset

Cashier Code (1 to 8)
 Gross Sales: Customer Count
 Item Count
 Amount
 Other Income Depts.: Total Item Count } (NOTE 1)
 Total Amount }
 Reset Count of each cashier's Reset Report (NOTE 2)
NOTES: 1. Initial Status: Non-print
 2. Prints on Reset Reports only

Periodical Cashier Read or Reset Report

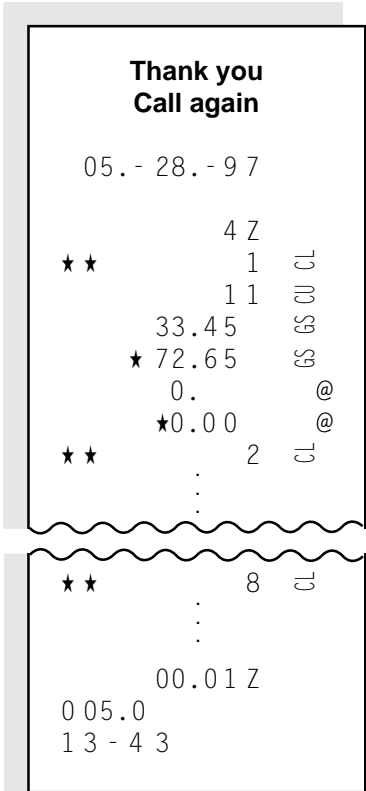

Report Type Symbol { 4X: Periodical All Cashier Read
4Z: Periodical All Cashier Reset

Sales Data by Cashier 1

Sales Data by Cashier 2 (format same as Cashier 1)

Sales Data by Cashier 8 (format same as Cashier 1)

Reset Count of All Cashier Reset Report
(printed on Reset Reports only)

Daily Individual Department Read Report

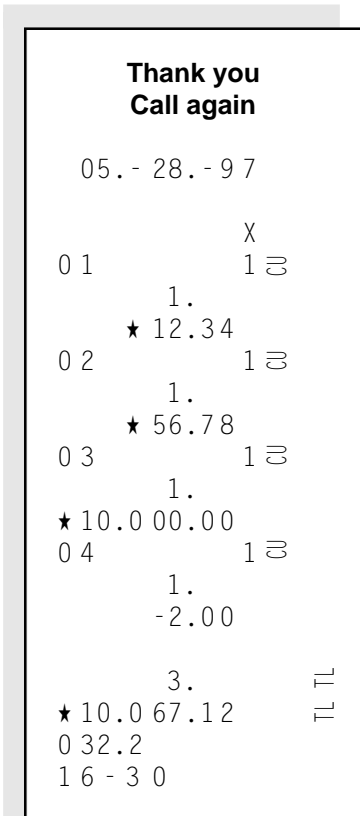

Report Type Symbol (Daily Read Report only)

Dept. 1: Customer Count

Item Count

Sales Amount

Dept. 2: Customer Count

Item Count

Sales Amount

Dept. 3: Customer Count

Item Count

Sales Amount

Dept. 4: Customer Count

Item Count

Sales Amount

Total of designated Depts.: Item Count (Positive Depts. only)

Amount (Positive Depts.-Negative Depts.)

16. System Option Setting

This operation is provided for your selections of the register's basic functions according to the market and your requirements.

Programming Procedure

The System Options are divided into 11 addresses (Addresses 1 to 16; Addresses 4, 5, 9, 10, and 12 are vacant) and each address is further divided into a maximum of 8 bits (Bits 1 to 8). Each address table is placed on the following pages.

Condition: After Daily Financial Reset (refer to "NOTE on Condition" on page 15)

Programming Procedure:

Use the **MA Key** to turn the Control Lock to "SET".

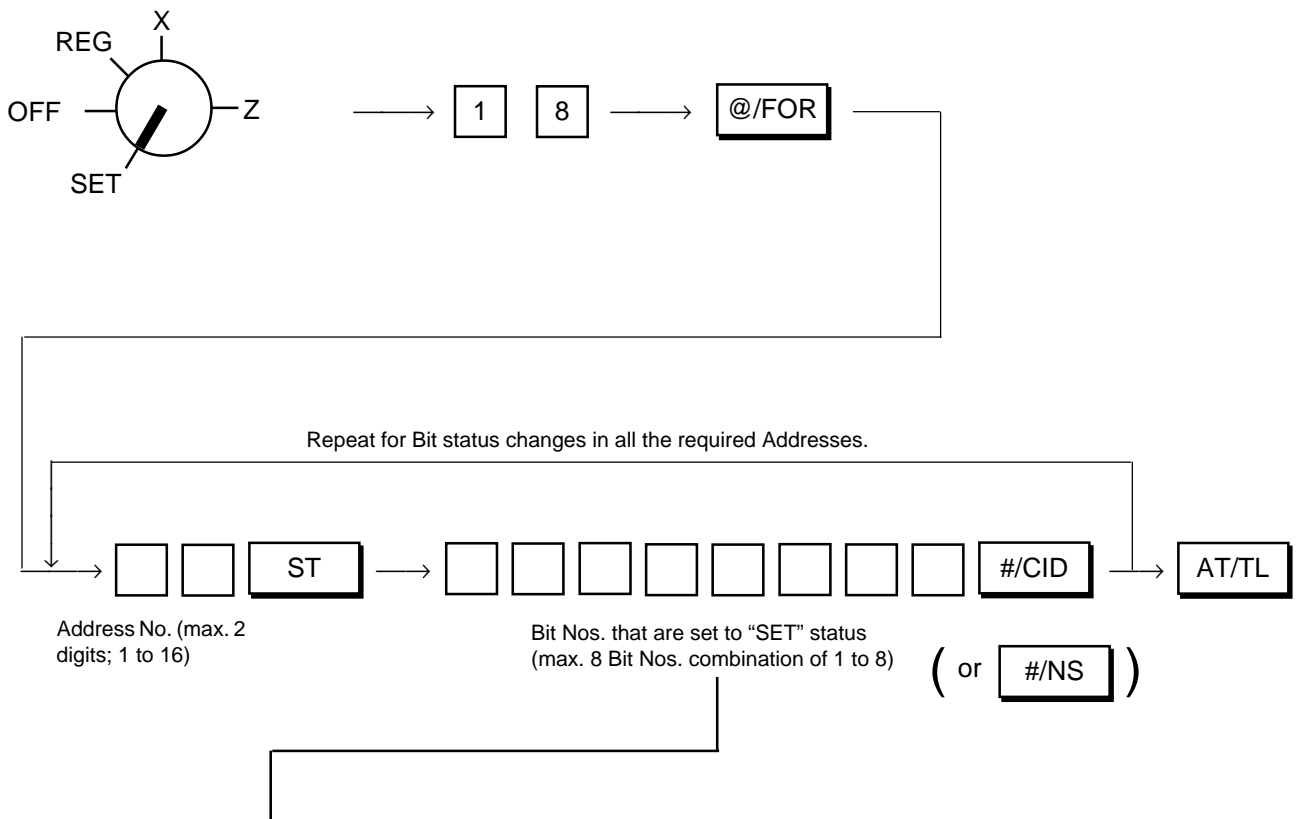

Enter a maximum of eight-digit number composed of Bit Nos. whose status must be set to the "SET" status in the Address. If there is no Bit No. to be set to the "SET" status, enter "0" for the Address.

- Examples) To set Bit 2 only Enter 2.
 To set Bits 2 and 3 Enter 23.
 To set all the Bits Enter 12345678.
 To reset all the Bits Enter 0.

To change any Bit in an address, enter the Address No. and enter all the SET Bit Nos. again. If a Bit No. is not included in the SET Bit Nos., the Bit will be RESET.

NOTES: 1. Do not program any Bit No. shaded and filled with "vacant" in the Address tables on the following pages. If programmed, performance of the register will not be guaranteed.

2. The Initial Status of each Bit is indicated by a dotted frame such as: [.]
 If you have never changed the Bit statuses in the Address before, the Initial Status is active. Therefore, only the Bit status changes of the required Addresses may be entered. If an All Memory Clear is operated (refer to Chapter "23. Status Clear and Memory Clear Operations" on page 104), all the Bits in all the Addresses automatically regain the Initial Status.

Programming Example) To select the following options:

Address 1 (refer to the next page)

Bit 1: Time NON-PRINT (**SET** status)

Bit 2: Purchased Item Count NON-PRINT (**SET** status)

Other Bits are to all RESET (PRINT)

Control Lock: **SET**

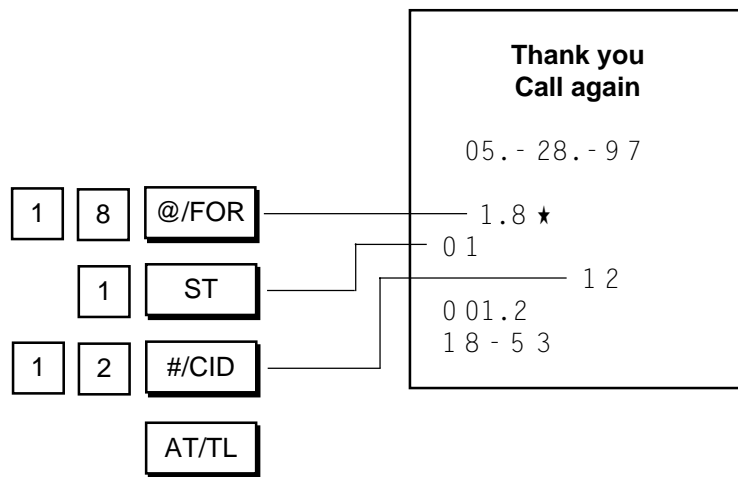

Address:

1

Initial SET Bit Nos.



2

6

Your Selection

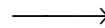

(Non-print Options 1)

Bit No.	Content	Selective Status	
		RESET	SET
1	Time on Journal and every Receipt in REG, X, Z, SET modes	PRINT	NON-PRINT
2	Purchased Item Count on Sale Receipts	PRINT	NON-PRINT
3	Manual Subtotal on Sales Receipts	PRINT	NON-PRINT
4	GT (Grand Total) on Financial Reports (in X and Z modes)	PRINT	NON-PRINT
5	-- vacant --		
6	Sum of Negative Department Data on Financial Reports (in X and Z modes)	PRINT	NON-PRINT
7	-- vacant --		
8	-- vacant --		

Address:

2

Initial SET Bit Nos. →

7 8

Your Selection →

□ □ □ □ □ □ □ □

(Optional Functions 1)

Bit No.	Content	Selective Status	
		RESET	SET
1	Fraction Rounding Process on Quantity Extension or % Calculations	Round OFF	ROUND UP
2	Fraction Rounding Process on Quantity Extension or % Calculations	Follow Bit 1 status.	ROUND DOWN
3	Credit Balance (over-subtraction of the sale by [DOLL DISC] or [VOID] key)	PROHIBITED	ALLOWED
4	Obtaining Taxable Total (sale total including taxes) by [TXBL TL] or [ST] key before finalizing each sale	NOT COMPULSORY	COMPULSORY
5	-- vacant --		
6	Department and Financial Items Zero Skip on Reports	NO ZERO-SKIP	ZERO-SKIP
7	Receipt or Journal (Printer Format)	Receipt-format	Journal-format
8	Cashier Identifying Function	Cashier Signing Method	Nothing

Supplementary Description for Address 2:

- Bit 1 & Bit 2: If both RESET, ROUND OFF status is obtained.
If both SET, Bit 2 status prevails, i.e., ROUND DOWN.
(Fraction Rounding Process on tax calculations is fixed to ROUND OFF, out of the application of the process selected here.)
- Bit 3: The [RTN MDSE] key is operable to turn the sale into negative regardless of this bit status selection.
- Bit 6: If SET status is selected, data of departments and financial items with no sales recorded will be skipped from printing on Financial Reports and Media Sales& In-drawer Reports.
- Bit 7: RESET (Receipt-format) Each transaction entry will print a sale receipt with the Store Name stamp printed. The receipt is cut and handed to the customer. If journal recording is required, you can use 2-ply paper rolls.
SET(Journal-format) The sales data will be printed in a journal format, eliminating store name stamping, line feeding, etc. When this status is selected, receipts will not be issued from the register.
- Bit 8: RESET (Cashier Signing Method) A maximum of 8 cashiers can operate the register. Refer to **Chapter 17** on page 82 for further details.
SET (Nothing) The register will operate without any cashier identifying operation.

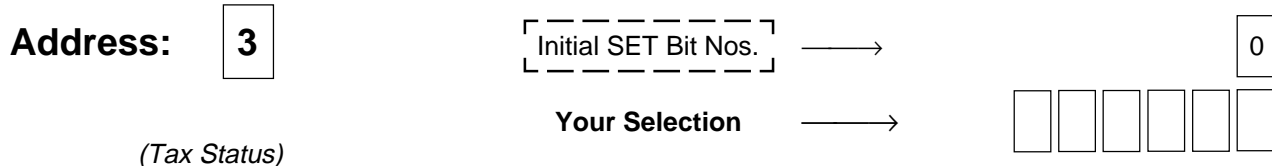

Bit No.	Content	Selective Status	
		RESET	SET
1	[% +] key PST/Tax Status	NON-TAXABLE	TAXABLE
2	[% -] key PST/Tax Status	NON-TAXABLE	TAXABLE
3	[DOLL DISC] key PST/Tax Status	NON-TAXABLE	TAXABLE
4	[% +] key GST Status	GST NON-TAXABLE	GST TAXABLE
5	[% -] key GST Status	GST NON-TAXABLE	GST TAXABLE
6	[DOLL DISC] key GST Status	GST NON-TAXABLE	GST TAXABLE
7, 8	-- vacant --		

Supplementary Description for Address 3:

Bit 1 & Bit 2: RESET status The key always operates as Non-taxable.
 SET status The key becomes PST/Tax Taxable if they are used after depressing the **[ST]** key. If the key is used after entering a Department or PLU item, the key obeys the Department PST/Tax status.

Bit 3: RESET status The key always operates as Non-taxable.
 SET status The key always operates as Taxable.

To make status selections of Bits 4 to 6 here, Address 14-Bit 1 "SET" status must be selected.

Bit 4 & Bit 5: RESET status The keys always operates as GST Non-taxable.
 SET status The key becomes GST Taxable if it is used after depressing the **[ST]** key. If it is used after entering a Department or PLU item, it obeys the Department GST status.

Bit 6: RESET status The key always operates as GST Non-taxable.
 SET status The key always operates as GST Taxable.

-- Addresses 4, 5 are vacant. --

Address:

6

Initial SET Bit Nos.



0

Your Selection

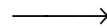

([AT/TL] Key Function)

Bit No.	Content	Selective Status	
		RESET	SET
1	Tender and Total Functions in finalizing a sale in REG mode	TENDER or TOTAL	TENDER only
2 to 8	-- vacant --		

Supplementary Description for Address 6:

Bit 1: RESET status The key functions as Tender Key with a prior amount entry or as Total Key without any amount entry.
 SET status The key always requires a tender amount entry.

Address:

7

[Initial SET Bit Nos.]



1 3

Your Selection

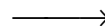

([CHK TND] Key Function)

Bit No.	Content	Selective Status	
		RESET	SET
1	Tender and Total Functions in finalizing a sale in REG mode	TENDER or TOTAL	[TENDER only]
2	-- vacant --		
3	Cashing with no purchase, using this key	PROHIBITED	[ALLOWED]
4	Over-tendering (tendering an amount larger than the sale total, resulting in calculation of change due)	[ALLOWED]	PROHIBITED
5 to 8	-- vacant --		

Supplementary Description for Address 7:

- Bit 1: Refer to the "Supplementary Description" of Bit 1 attached to Address 6 on the preceding page.
- Bit 3: RESET status Customers' checks cannot be cashed outside a sale.
SET status..... Customers' checks can be cashed with no purchase outside a sale.
- Bit 4: This Bit status selection is effective only in tendering operation.
SET status..... If this bit is SET and also Address 11 - Bit 1 is SET (for Short-tendering Prohibited), an amount equal to the sale total is always required for tendering.

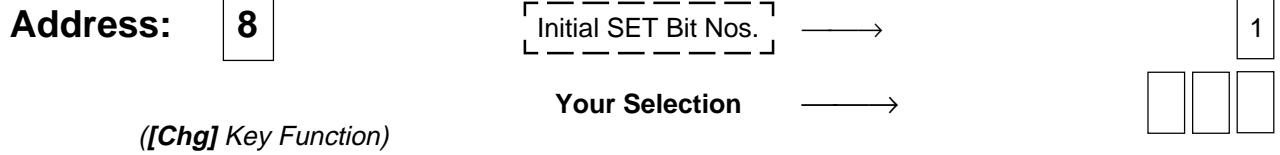

Bit No.	Content	Selective Status	
		RESET	SET
1	Tender and Total Functions in finalizing a sale in REG mode	TENDER or TOTAL	<input type="text" value="TOTAL only"/>
2	-- vacant --		
3	Cashing with no purchase, using this key	<input type="text" value="PROHIBITED"/>	ALLOWED
4	Over-tendering (tendering an amount larger than the sale total, resulting in calculation of change due): effective only when Bit 1 is RESET	<input type="text" value="ALLOWED"/>	PROHIBITED
5 to 8	-- vacant --		

Supplementary Description for Address 8:

- Bit 1: RESET status The key functions as Tender Key with a prior amount entry or as Total Key without any amount entry.
 SET status..... The key functions as Total Key only.
- Bit 3: RESET status Cashing with no purchase is prohibited.
 SET status..... Cashing with no purchase is allowed outside a sale.
- Bit 4: This Bit status selection is effective only in tendering operation and only when Bit 1 is RESET.
 SET status..... If this bit is SET and also Address 11 - Bit 1 is SET (for Short-tendering Prohibited), an amount equal to the sale total is always required for tendering.

-- Addresses 9, 10 are vacant. --

Address:

[Initial SET Bit Nos.] →

Your Selection →

(Optional Functions 2)

Bit No.	Content	Selective Status	
		RESET	SET
1	Short-tendering using any media key (applicable to [AT/TL] , [CHK TND] , [Chg])	[ALLOWED]	PROHIBITED
2	Sum of All Department Data on Financial Reports (in X and Z modes)	[NON-PRINT]	PRINT
3	Sum of Other Income Department Data on Financial and Cashier Reports (in X and Z modes)	[NON-PRINT]	PRINT
4	-- vacant --		
5	Electronic Journal Function	[NON-ACTIVE]	ACTIVE
6	Electronic Journal is automatically issued after taking a Daily Financial Reset Report.	NON-ACTIVE	[ACTIVE]
7	IPD (Items Print Detail) or INPD (Items Not Print Detail) on Electronic Journal	[IPD]	INPD
8	Electronic Journal Memory Warning Alarm	NON-ACTIVE	[ACTIVE]

Supplementary Description for Address 11:

- Bit 5: When the SET status (Electronic Journal Active) is selected, the following features are applied:
- 1) The sales entries in the "REG" mode are recorded in the Electronic Journal Memory.
 - 2) Both receipt-format and journal-format are recorded on the Electronic Journal.
 - 3) When the Electronic Journal buffer becomes full, only the finalization operation is available.
 - 4) When the remaining number of lines to be printed in the Electronic Journal buffer becomes 300 or less, the "ALM" lamp illuminates after the current sale is finalized. The lamp is extinguished by a numeric entry or by pressing the **[C]** key.
 - 5) Sales entries in the Training Mode are also stored in the Electronic Journal buffer.
- Bit 6: If SET status is selected, the Electronic Journal is automatically issued after taking a Daily Financial Reset Report. However, this bit becomes effective only when Bit 5 (Electronic Journal Function) is in SET status.
- Bit 7: If SET status is selected, the details of the Dept/PLU entries are not stored in the Electronic Journal buffer. However, the returned merchandise, item correct, negative Dept/PLU and void are stored.
- Bit 8: If SET status is selected, the alarm beeps for about two seconds after the current sale is finalized when the remaining number of lines to be printed in the Electronic Journal buffer becomes 300 or less.

-- Address 12 is vacant. --

Address:

1 3

[Initial SET Bit Nos.] →

2

Your Selection →

(Non-print Options 2)

Bit No.	Content	Selective Status	
		RESET	SET
1	"Net Sale With Tax" Line on Financial Reports	[PRINT]	NON-PRINT
2	"Net Sale Without Tax" Line on Financial Reports	PRINT	[NON-PRINT]
3	Tax (PST) Amount Line(s) on Sale Receipts when Tax (PST) 1 and Tax (PST) 2 are programmed.	[CONSOLIDATED LINE (into one tax amount)]	SEPARATE PRINT LINES
4 to 8	-- vacant --		

Supplementary Description for Address 13:

Bit 3: RESET status The tax amount line is only one, consolidating the amounts of the two taxes into one.
 SET status The amounts of the two taxes are printed on individual lines. This status selection is effective only when Address 14 - Bit 5 is SET in case of the GST feature (for GST separate print from PST).

Address:

1	4
---	---

[Initial SET Bit Nos.] →

4	5
---	---

Your Selection →

--	--	--	--	--	--

(GST Options) ... for CANADA

Bit No.	Content	Selective Status	
		RESET	SET
1	GST Feature (for Canada only)	[NOT ADOPTED] <i>(All bit status selections below are disregarded)</i>	ADOPTED
2	Fraction Rounding Process on GST Calculations.	[Follow Bit 3 status.]	ROUND UP
3	Fraction Rounding Process on GST Calculations.	[ROUND OFF]	ROUND DOWN
4	GST Amount Lines on Sales Receipts	NON-PRINT	[PRINT]
5	PST & GST Amount Lines Print Format on Sales Receipts (when Bit 4 is SET)	CONSOLIDATED AMOUNT LINE	[SEPARATE LINES]
6	Sale amount subject to PST calculation	[INCLUDING GST]	EXCLUDING GST
7, 8	-- vacant --		

Supplementary Description for Address 14:

- Bit 2 & Bit 3: If both RESET, ROUND OFF status is obtained.
If both SET, Bit 3 status prevails, i.e., ROUND DOWN.
(For Fraction Rounding Process on Quantity Extension and % calculations, see Address 2 - Bits 1 & 2. As for fraction rounding process on PST calculations, ROUND OFF status is fixed.)
- Bit 5: If SET status is selected, you can further select printing of PST 1 and PST 2 on one consolidated line or separate lines. (See Address 13 - Bit 3.)
- Bit 6: If SET status is selected, PST calculation is performed on the sale amount subject to PST with GST excluded.
If RESET status is selected, PST calculation is performed on the sale amount subject to PST with GST included.

Address:

1 **5**

[Initial SET Bit Nos.] →

4

Your Selection →

(Optional Functions 3)

Bit No.	Content	Selective Status	
		RESET	SET
1	No-sale Transaction Entry After Non-add Number Print Entries	[PROHIBITED]	ALLOWED
2	Receipt Consecutive No. on Journal and every Receipts in any mode	[PRINT]	NON-PRINT
3	Receipt Consecutive No. Resetting	[NON-RESETTABLE]	RESETTABLE
4	Amount Display by [ST] key depression during a sale	SUBTOTAL (Sale Total excluding Taxes)	TAXABLE TOTAL (Sale Total including Taxes)
5 to 8	-- vacant --		

Supplementary Description for Address 15:

Bit 1: RESET status Non-add Numbers cannot be printed on No-sale receipts.
SET status Non-add Numbers can be printed on No-sale receipts.

Bit 3: RESET status The Consecutive No. will increment every time a receipt is issued or a transaction is finalized. It is non-resettable.
SET status When a Daily Financial Reset Report is issued, the Consecutive No. is automatically reset. On the first receipt issued after the reset report, the Consecutive No. "0001" will be printed. If this status is selected, it is recommended to take the Daily Financial Reset Report at the end of all operations on the register for the day (so that the first receipt will always start with Consecutive No. 0001 every day).

Bit 4: RESET status This status should be selected when both **[ST]** and **[TXBL TL]** keys are installed on the keyboard. Then **[ST]** displays SUBTOTAL while **[TXBL TL]** displays TAXABLE TOTAL.
SET status This status should be selected when only **[ST]** is installed but not **[TXBL TL]**.
(Depressing **[ST]** always prints (if "PRINT" option is selected at Address 1 - Bit 3) SUBTOTAL regardless of this bit status selection.)

Address:

1	6
---	---

[Initial SET Bit Nos.] →

2	8
---	---

Your Selection →

--	--	--	--

(Optional Functions 4)

Bit No.	Content	Selective Status	
		RESET	SET
1	Drawer-close before starting any operation	[NOT COMPULSORY] [See NOTE below]	COMPULSORY
2	Number of times allowed for % (% + or % -) entries after once depressing [ST] during a sale	ANY NUMBER OF TIMES	[ONLY ONCE]
3 to 6	-- vacant --		
7	Date Setting and Print Order	[Follow Bit 8 status.]	Day-Month-Year
8	Date Setting and Print Order	Year-Month-Day	[Month-Day-Year]

Supplementary Description for Address 16:

- Bit 1: RESET status Any operation is possible with the drawer kept open.
 SET status..... If any operation is attempted in REG mode with the drawer kept open, an error results and keys on the keyboard are locked.
- Bit 2: RESET status Even when a % is entered after once obtaining a subtotal during a sale, another % entry is possible if preceded with a prior depression of the [ST] key.
 SET status..... A second % entry after once entering a % after a subtotal within a sale will cause an error.
- Bit 7 & Bit 8: Both RESET Year-Month-Day order
 Both SET Bit 7 status prevails, i.e., Day-Month-Year order.

17. Cashier Signing Operation (optional function)

The register will operate without any cashier identifying operation in the initial status. However, the register can be changed to require cashier signing for operating sale entries.

Programming Requirements

1. Install the **[LOG/RECEIPT]** key (SFKC 127) on the keyboard. (Refer to **Chapter 11** on page 21.)
2. Select the RESET status (for Cashier Signing Method) for **System Option Address 2 - Bit 8**. (Refer to **Chapter 16** on page 69.)

Cashier Sign ON & Sign OFF



/Receipt Key)

A cashier needs to "sign ON" for starting transaction entries on the register and identifying the operator. The signed-ON condition is held until a "sign OFF" is operated. A cashier can sign ON only when the register is in the signed-OFF condition.

Sign ON (operable in signed-OFF condition)

Use the **REG Key** to turn the Control Lock to the **REG** position.

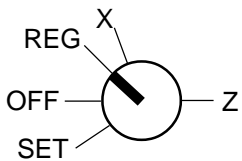

The code being entered is not displayed.

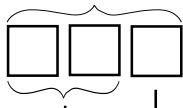

The "SIGN ON" triangular lamp illuminates, and a Sign ON receipt is issued.



Transaction entries are now possible.

Cashier Code assigned to each cashier by the store (1 digit; 1 to 8)

Secret Code generated by the cashier (2 digits; any number from 01 to 99)
See **NOTE 1** on the next page.

Sign OFF (operable in signed-ON condition)

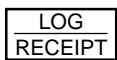
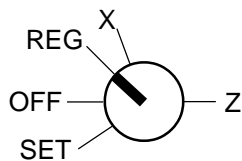

No operation in REG mode will be allowed until a Sign ON is operated by a cashier. (Operations in X, Z, or SET are possible even in this condition.)

The "SIGN ON" triangular lamp is extinguished, and a Sign OFF receipt is issued.

Sign ON Receipt Format

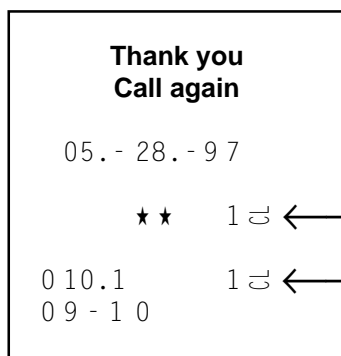

Cashier Code (1 to 8)

The signed-ON Cashier Code is printed on every sale receipt. (The Secret Code portion is never printed.)

Sign OFF Receipt Format

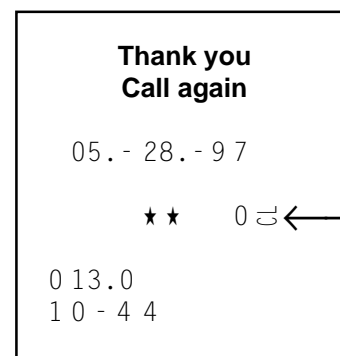

Sign OFF Code (always 0)

- NOTES:**
1. The two-digit Secret Code portion, once entered for a cashier's Sign ON, is set in the memory of the register. The Secret Code of the same cashier is checked every time his/her Sign ON is operated until the Daily Cashier Reset Report is taken at the end of the day. Then the Secret Code is reset and a new Secret Code entry will be allowed. When the Secret Code is within the range of 01 to 09, it may be omissible to enter the preceding zero.
 2. If the **[LOG/RECEIPT]** key is simply depressed without a prior numeric entry, the Receipt ON/OFF function is activated (refer to the first section in **Chapter 14** on page 27) but not Sign ON/OFF.
 3. If the Cashier Identifying Function "NOTHING" (SET status) is selected (refer to Chapter "16. System Option Setting," Address 2 - Bit 8 on page 69), an error will result on a Sign ON or Sign OFF attempt.

Cashier Reports

By adopting the Cashier Signing Method, Daily Cashier Read and Reset Reports (for individual cashiers) and Periodical Cashier Read and Reset Reports (for all the cashiers together in one report) are available. For the report taking operations and print format, see **Chapter 15** on page 59.

18. Electronic Journal (E.J.) Print (optional function)

Electronic Journal is a new state-of-the-art electronic feature that enables you to generate a detailed record (journal) of your sales activity without using high cost 2-ply paper. Via this feature the sales entries will be electronically stored in the ECR memory instead of printing at the time of each sales entry. (Up to 2150 lines can be stored in the electronic journal memory.)

Programming Requirement

- Select the SET status (Electronic Journal Function Active) for **System Option Address 11 - Bit 5**. (Refer to **Chapter 16** on page 69.)

One of the following can further be selected as to the way of issuing the Electronic Journal Report: (Refer to Chapter "16. System Option Setting", Address 11 - Bit 6 on page 77.)

- Electronic Journal is automatically issued after taking a Daily Financial Reset Report as well as by the manual issuing operation as described on the next page.
- Electronic Journal is issued only by the manual issuing operation as described on the next page.

E.J.-Near-Full Warning in REG Mode

When the remaining number of lines in the E.J. buffer becomes 300 or less, the "ALM" lamp illuminates after finalizing the current transaction (and the alarm may beep according to an option selection). In that case, you can operate one of the following:

- Immediately take an Electronic Journal Report (described on the next page) to print and clear the E.J. buffer contents.
- or
- Continue entering several more transactions before the E.J. buffer becomes full. The "ALM" lamp will be cleared by depressing numeric keys or the **[C]** key. The lamp will illuminate again on finalizing each transaction to follow.

CAUTION: *Even if the E.J. buffer becomes full, a subsequent entry is not prohibited. However, in this case, record data stored in the ECR memory will be superscribed.*

Reading of the Remaining Lines of E.J. Memory

This operation is used to display the remaining number of lines in the E.J. buffer. The remaining number of lines is displayed in the Amount portion of the display.

Operation

Use **MA Key** to turn the Control Lock to "X".

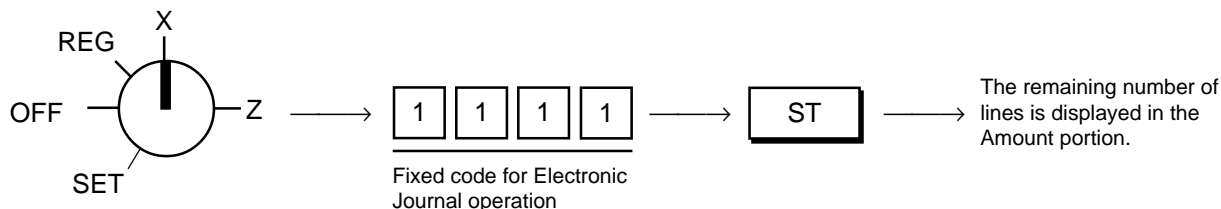

Electronic Journal Report

Whenever the contents stored in the Electronic Journal is to be printed, operate the following. Even if the "Electronic Journal Automatically Issued" option is selected, this operation is effective.

Operation

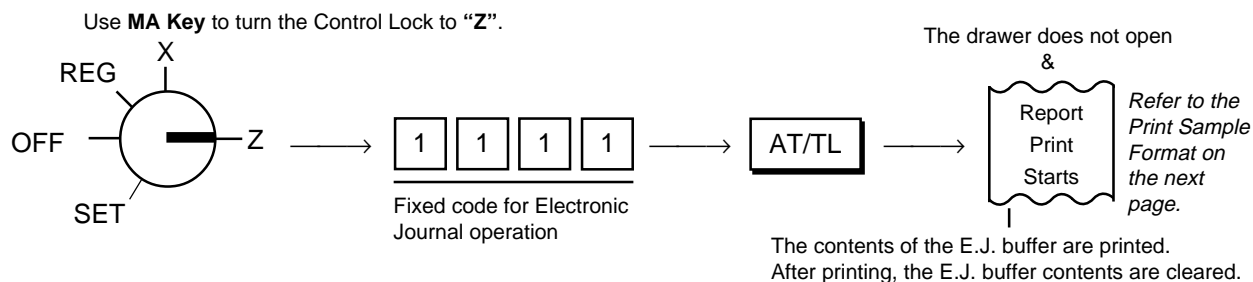

WARNING: Electronically stored Journals could possibly be lost partially or completely in the event of serious hardware or other malfunctions. TOSHIBA TEC and Dealers, Distributors, and Resellers will have no responsibility for financial or other damages arising from loss or damage to Electronic Journal information. When the Electronic Journal feature is utilized, it will be the user's responsibility to ensure the security of the collected data.

Print Sample Format of Electronic Journal

```

Thank you
Call again

05.-28.-97

          Z
          1 CL
    **
010.1    1 CL
09-10
    * NS
010.2    1 CL
09-10
          15 #
    * 10.00
    * 2.50
    * 12.50
          1 CL CA RA
010.3
09-10
  
```

```

02    *4.50
      14. X TM
      0.30 @
03    *4.20 TM
20.0
    * 10.00 TM
    * 18.70 ST
    *****
012.7 2 CL VD
10-42
    ** 0 CL
032.0
16-10
  
```

- NOTES:**
1. The E.J. buffer contents are cleared whenever an Electronic Journal Report is printed automatically or by the manual operation. Therefore, the printout data always shows the sales data recorded in the period between the two Electronic Journal Reports (the one taken last time and the one taken now.)
 2. The print sample format on the left shows an example when the "IPD (Items Print Detail)" option is selected. You can select the "INPD (Items Not Printed Detail)" option, which will skip detail positive items but print only negative items and transaction totals. Refer to Chapter "16. System Option Setting, Address 11 - Bit 7" on page 77.

19. Program Data Verification

Whenever programming operations are performed, it is recommended to issue Program Verification receipts to check the programmed data before entering any other operation.

Operating Procedure

Condition: Any time outside a sale

Operating Procedure:

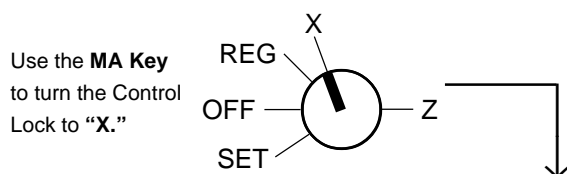

The "R OFF" lamp must be extinguished when the Receipt-format Option has been selected. If it is illuminated, press the **[LOG/RECEIPT]** key to extinguish the lamp.

			<i>Contents to be Printed for Verification</i>	<i>Format Page</i>
→	1	ST	Department Preset Price Read: Preset Price of each Department	87
→	2	ST	Department LC and Status Read: LC(Listing Capacity) and Status of each Department	87
→	3	ST	PLU Table Read: Preset Price and Link Department of each PLU	88
→	4	ST	Other Programmed Data Read: %+ & %- Preset Rates, common LC for All Departments, GST Rate, Non-taxable Amount Limit for Canada Tax	88
→	9	ST	System Option Read: System Option Setting	89

Department Preset Price Read

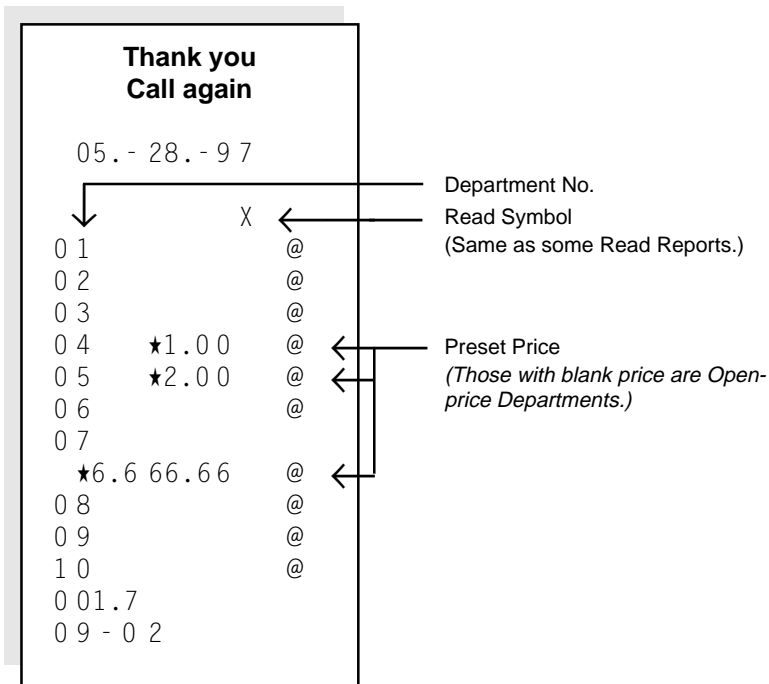

Department LC and Status Read

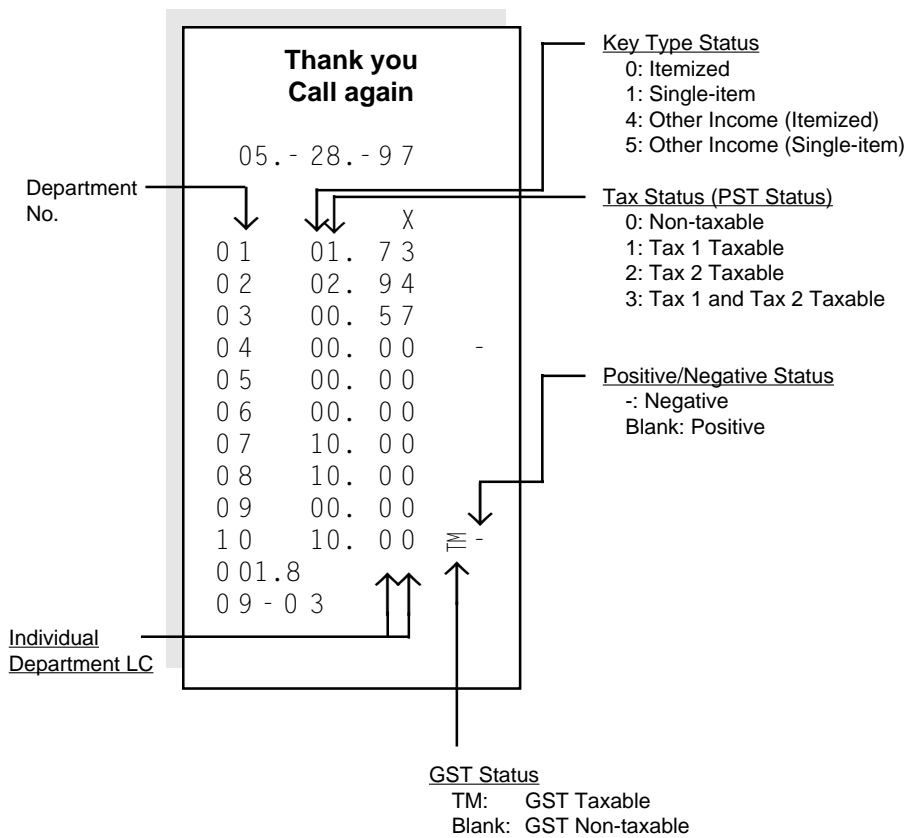

PLU Table Read

Thank you Call again	
05.- 28.- 9 7	
	X
↙	
⌘00.5 0 4	← PLU Code
★1.00 @	← Link Department No.
⌘01.1 0 1	← Preset Price
★1 23.45 @	(Blank Price means an Open-price PLU.)
⌘05.0 0 5	
★0.50 @	
⌘06.0 1 0	
★3.00 @	
⌘07.0 0 3	
@	←
⌘07.1 0 8	
★8.00 @	
⌘07.2 0 9	
★9.00 @	
⌘19.9 0 3	
★ 10.00 @	
0 01.9	
0 9 - 0 4	

Other Programmed Data Read

Thank you Call again	
05.- 28.- 9 7	
	X
8 6	← Common LC for All Departments
10. % +	← %+ Preset Rate
10. % -	← %- Preset Rate
7. T	← GST Rate (if GST Feature is selected)
★ 20.00 TX	← Non-taxable Amount Limit (Canada Tax)
0 10.3	
0 9 - 0 5	

System Option Read

Thank you Call again	
05 . - 28 . - 9 7	
↓	X
0 1	
	2 6 ←
0 2	
	7 8
0 3	
	0
0 4	
	0
0 5	
	0
0 6	
	0
0 7	
	1 3
0 8	
	1
0 9	
	0
1 0	
	0
1 1	
	6 8
1 2	
	0
1 3	
	2
1 4	
	4 5
1 5	
	4
1 6	
	2 8
0 0 2 . 2	
0 9 - 0 8	

NOTE: The above sample shows the initial SET Bit Nos. of each Address.

20. Paper Roll Replacement and Other Maintenance

Replacing the Paper Roll (When used for receipt)

When a red line appears on the edge of the paper roll, follow the steps below to replace the paper roll with a new one.

WARNING!

Care must be taken not to injure yourself with the paper cutter.

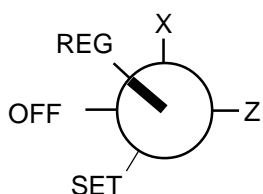

1

Turn the Control Lock to the REG position using the Control Key.

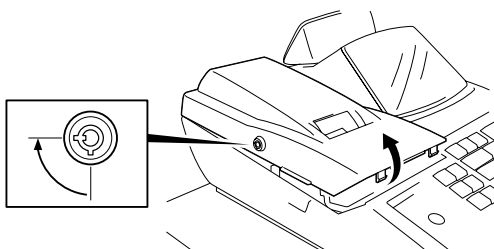

2

To remove the Printer Cover, insert the Printer Cover Key to the Printer Cover Lock, and then turn it 90° clockwise.

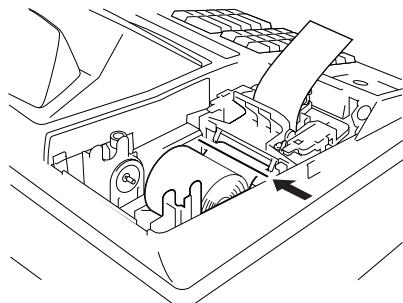

3

Cut the paper as shown in the figure.

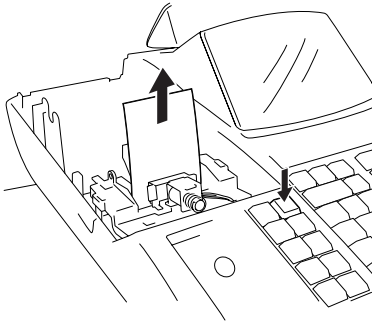

4

Depress the **[FEED]** key to feed the remaining paper end.

CAUTION: *Never try to pull out the remaining paper end by hand. It may cause a paper jam.*

5

Load new paper roll as described in Chapter 10.

* When the 2-ply paper is used, refer to Chapter 8 on page 10 to replace it with a new one.

Replacing the Paper Roll (When used for journal)

After a reset report is taken or when a red line appears on the edge of the paper roll, follow the steps below to obtain the necessary record or replace the paper with a new one.

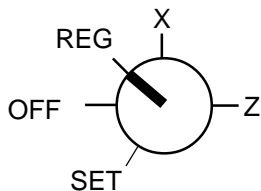

1

Turn the Control Lock to the REG position using the Control Key.

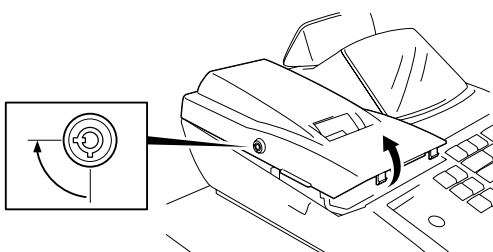

2

To remove the Printer Cover, insert the Printer Cover Key to the Printer Cover Lock, and then turn it 90° clockwise.

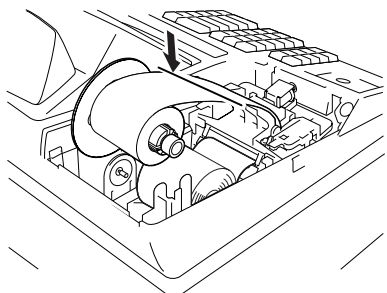

3

Depress the **[FEED]** key to wind the printed record to the Journal Take-up Reel. Cut the portion where nothing is printed.

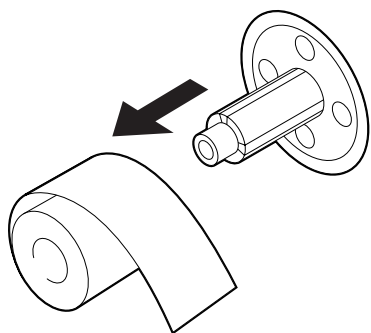

4

Remove the Journal Take-up Reel from the holder, then remove the wound-up portion of the paper by pulling it sideways.

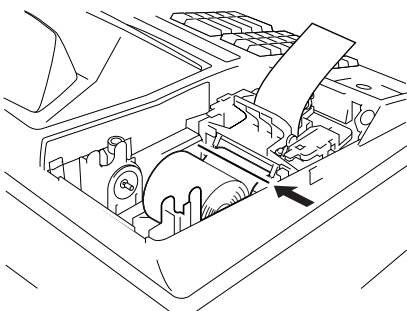

5

Cut the paper as shown in the figure.

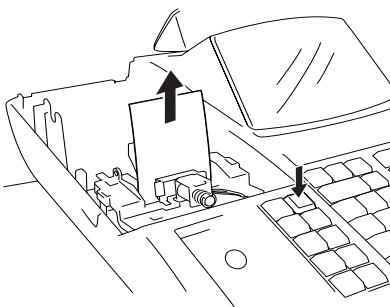

6

Depress the **[FEED]** key to feed the remaining paper end.

CAUTION: *Never try to pull out the remaining paper end by hand. It may cause paper jamming.*

7

Return the paper roll if it remains enough or load new paper roll as described in Chapter 8 on page 10. Attach the Printer Cover.

Replacing the Ink Ribbon

This ink ribbon is a consumable part and a TOSHIBA TEC's exclusive. Ask your TOSHIBA TEC representative about the order of the ink ribbon.

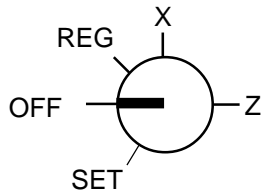

1

Turn the Control Lock to the OFF position using the Control Key.

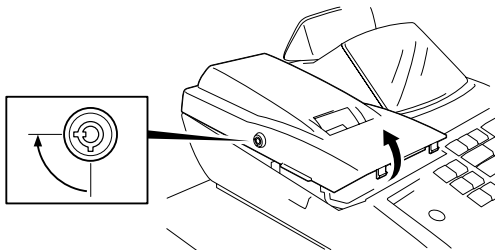

2

To remove the Printer Cover, insert the Printer Cover Key to the Printer Cover Lock, and then turn it 90° clockwise.

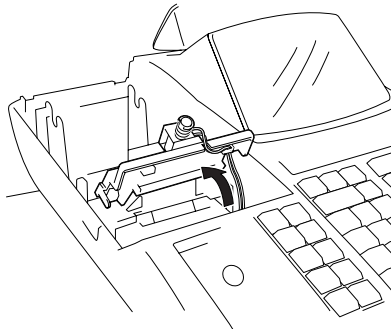

3

Lift the Stamp Unit as shown in the figure, then remove the ribbon by pulling the ribbon spools upward.

4

Install one of the ribbon spools as shown in the figure while moving the ribbon detector so that the ribbon is not caught.

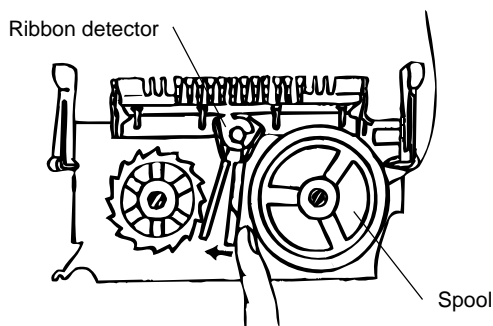

5

Thread the ribbon around the ribbon buffer, and then install the other ribbon spool while pushing the ribbon detector aside so that it may not catch the spool.

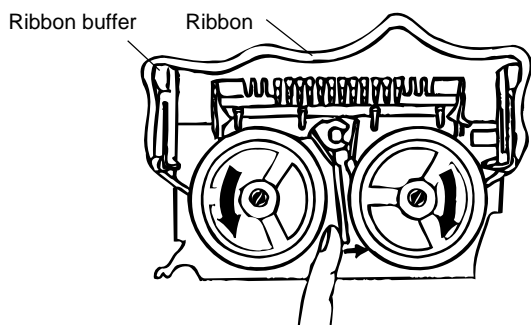

6

Turn the ribbon spool several times to remove the slack in the ribbon. (Select the ribbon spool which rotates in the direction of the arrow shown in the figure.)

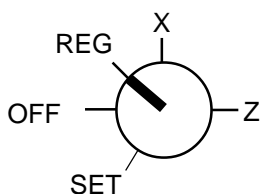

7

After replacing the ink ribbon, attach the Printer Cover, then turn the Control Lock to the REG position using the Control Key. Depress the **[NS]** key to check the print condition.

Replenishing Ink to the Store Name Stamp

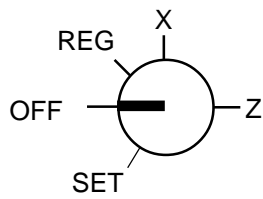

1

Turn the Control Lock to the OFF position using the Control Key.

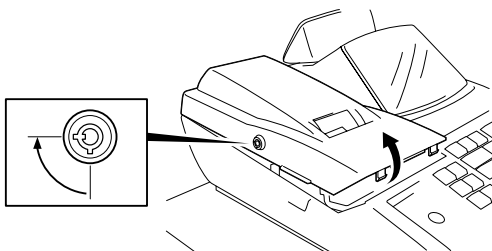

2

To remove the Printer Cover, insert the Printer Cover Key to the Printer Cover Lock, and then turn it 90° clockwise.

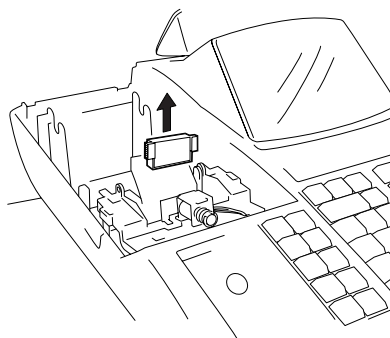

3

Remove the Stamp from the Stamp Print Unit by pulling out toward the rear of the register with your fingers on the notches of both sides as shown in the figure.

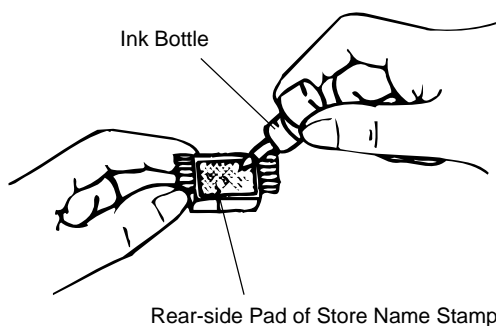

4

Apply ink to the pad on the rear side of the stamp. The amount of the refilling should be adjusted according to the density of the printed message, but the limit of 2 cc should not be exceeded. (The ink bottle supplied contains 5 cc of ink.)

- NOTES:**
1. Replenish the ink drop by drop several times until the pad does not absorb any more.
 2. Allow time for ink to saturate the stamp.

5

Return the stamp in the reverse procedure.

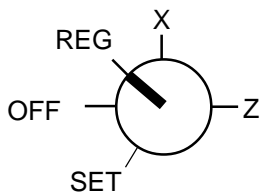

6

After replenishing ink, depress the **[NS]** key to check the density of the printed message.

* Ordering a Store Name Stamp which contains your store name, address, and telephone No., etc. is available. Refer to page 109 for details.

Manual Drawer Release and Lock

The drawer opens automatically when a registration is performed. In the event of a power failure or other trouble, the drawer can be opened manually in the following manner.

WARNING!

When opening the cash drawer, be careful not to let the drawer hit any person.

Releasing

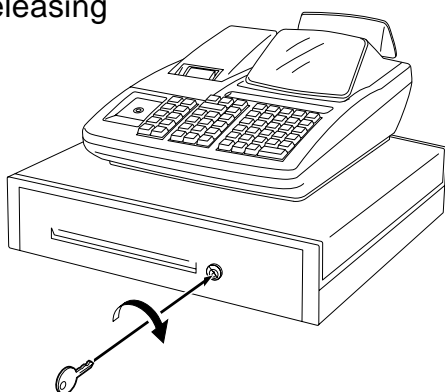

Insert the Drawer Release Key into the Drawer Release Lock, then turn the key clockwise. The drawer will now open. The Drawer Release Key can be taken out by returning it to the original position.

Locking

When the drawer is closed, it is automatically locked and will not open without the Drawer Release Key or transaction entries.

Removing the Drawer

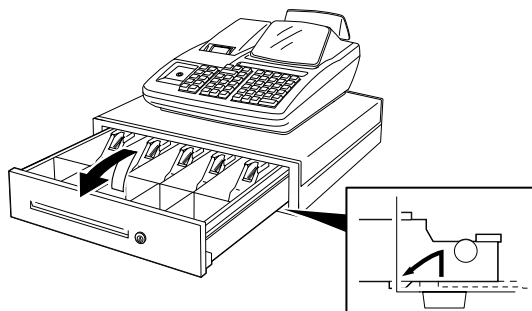

1

Pull the drawer out, and when it stops by the stopper, lift the drawer up and pull it again.

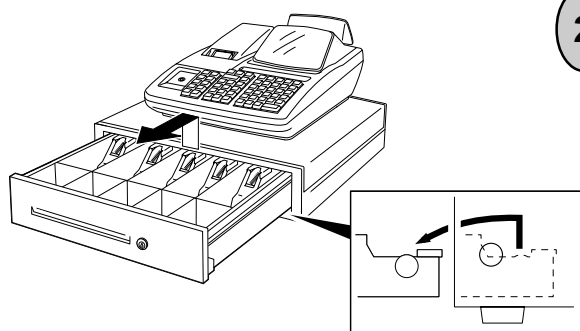

2

When it stops again by the roller fixed in the drawer case, lift it and pull it again.

Battery Exchange

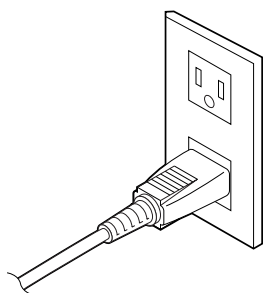

1

To exchange batteries, please keep the power cord of the register connected to the wall outlet. If the batteries are removed with the power cord disconnected, the programmed data and sales data will all be cleared.

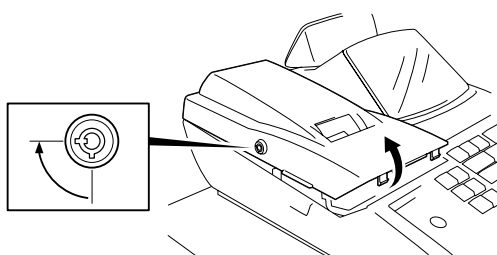

2

To remove the Printer Cover, insert the Printer Cover Key to the Printer Cover Lock, and then turn it 90° clockwise.

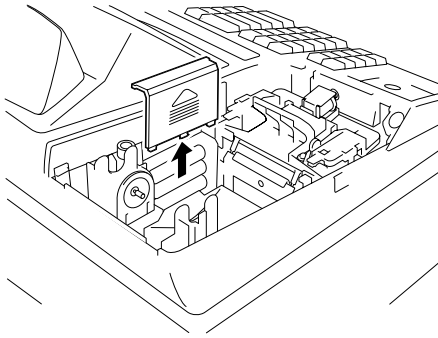

3

Remove the paper roll, the Take-up Reel (if used for Journal), and the Battery Cover.

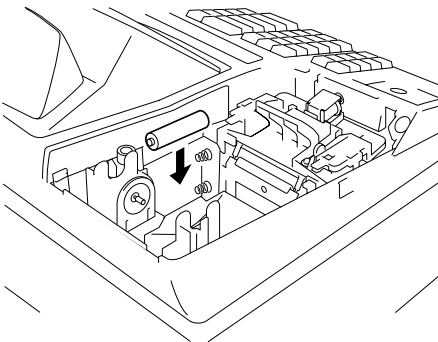

4

Replace the old batteries with new ones. (Batteries: SUM-3 1.5V x 3 pieces)

NOTE: Do not mix used and new batteries in the battery compartment.

5

Return the items removed in Step 3, and attach the Printer Cover.

Changing the Layout of the Money Case

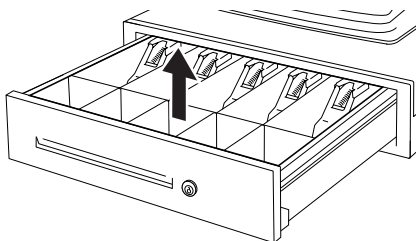

1

Open the drawer, then take the Money Case out.

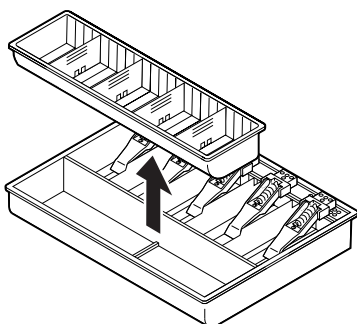

2

Remove the Coin Case from the Money Case.

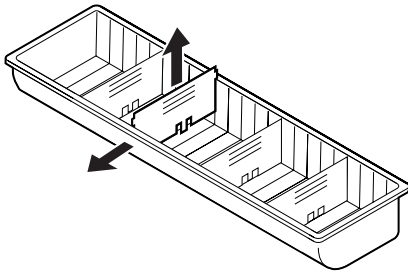

3

To remove the Partition from the Coin Case, pull the Partition upward while pushing the Coin Case outward.

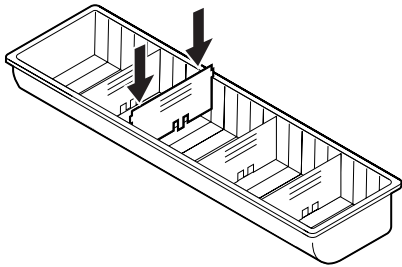

4

Set the Partition in the groove of the place where you like to set, then push the Partition downward.

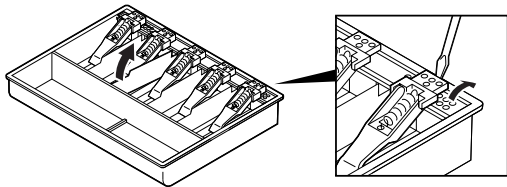

5

To change the layout of the Bill Case, it is necessary to remove the Bill Holder. To remove the Bill Holder, insert the tip of the phillips screwdriver in the back of the Bill Holder, then push the phillips screwdriver downward. To remove the Partition, pull the front of the Partition upward.

Media Slot

The Media Slot provided at the front of the drawer is used to put non-cash media such as check in the drawer without opening it. The non-cash media put from this slot are kept under the Money Case, therefore you can keep them in secret.

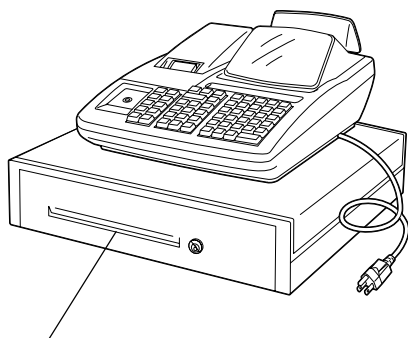

Media Slot

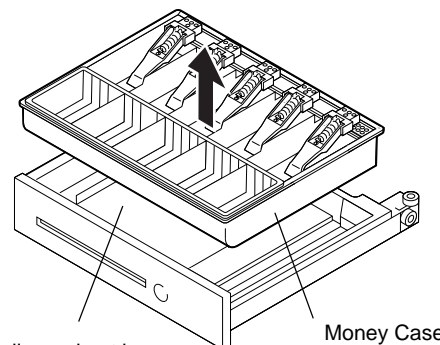

Non-cash media are kept here.

Money Case

21. In Case of the Power Failure

If a power failure occurs during business hours, all sales data stored in the memory are automatically protected by the batteries installed in the register. When any data was being printed on the power failure, the same data is automatically printed at the power recovery. In case of the power failure, it is suggested to check the receipt print contents before you hand the receipt to the customer.

22. Troubleshooting

The following are possible causes and measures against typical troubles. When a trouble occurs, refer to this chapter to find a cause of the trouble, then take appropriate measures. If a trouble not described here occurs, or a trouble still exists after taking the following measures, ask the store where purchased. In this case, inform the store where purchased of your trouble in details.

1. Trouble concerning Power Supply
2. Trouble concerning Printer
3. Trouble concerning Keyboard
4. Trouble concerning Drawer
5. Trouble concerning Display
6. Trouble during Normal Operations
7. Trouble in the REG Mode
8. Trouble in the SET Mode

WARNING!

If you cannot solve a problem with the following solutions, do not attempt to repair it yourself. Turn the power off, then contact your TOSHIBA TEC representative for assistance.

1. Trouble concerning Power Supply

Power is not turned ON.

- | | |
|--------------|--|
| Cause 1: | Register is not plugged in. |
| Measure: | Plug in an outlet. |
|
Cause 2: |
Control Lock is in the OFF position. |
| Measure: | Turn the Control Lock to the positions other than OFF using the Control Key. |
|
Cause 3: |
The outlet does not supply the power. |
| Measure: | Use another outlet. |

2. Trouble concerning Printer

Printer does not perform the paper feeding.

- | | |
|--------------|--|
| Cause 1: | Paper roll is not placed correctly. |
| Measure: | Place the paper roll correctly. (Refer to page 10.) |
|
Cause 2: |
Paper fragment or foreign substance blocks the inside of the paper path. |
| Measure: | Printer provided for this register is a precision machine, therefore ask the store where purchased. |
|
Cause 3: |
Triangular lamp "R OFF" on the display is illuminated when the Receipt Format Option has been selected. (Chapter "16. System Option Setting", Address 2 - Bit 7 on page 72.) |
| Measure: | Depress the [LOG/RECEIPT] key to extinguish this lamp. (Refer to page 27.) |
|
Cause 4: |
Failure of the printer itself |
| Measure: | Ask the store where purchased. |

Paper roll wrinkles.

- Cause 1: Paper roll is not placed correctly, or placed on the skew.
Measure: Place the paper roll correctly. (Refer to page 10.)
- Cause 2: Failure of the printer itself
Measure: Ask the store where purchased.

Printer prints nothing.

- Cause 1: Ink ribbon is not installed.
Measure: Install the Ink ribbon. (Refer to page 93.)
- Cause 2: Ink ribbon reaches its life, deteriorates, or is damaged.
Measure: Replace the Ink ribbon with a new one.
- Cause 3: Failure of the printer itself
Measure: Ask the store where purchased.

Printing as a whole is too light.

- Cause 1: Ink ribbon reaches its life, deteriorates, or is damaged.
Measure: Replace the Ink ribbon with a new one. (Refer to page 93.)

Printing gets stained.

- Cause 1: Printer drum gathers paper dust.
Measure: It is necessary to clean the inside of the printer, therefore ask the store where purchased.

Printing is uneven or too light.

- Cause 1: Ink ribbon reaches its life, deteriorates, or is damaged.
Measure: Replace the Ink ribbon with a new one. (Refer to page 93.)

Abnormal sound generates.

- Cause 1: Paper roll or ink ribbon is not placed correctly.
Measure: Place the paper roll or ink ribbon correctly. (Refer to page 10 or 93.)
- Cause 2: Failure of the printer itself
Measure: Ask the store where purchased.

Stamp does not work.

- Cause 1: Stamp is not installed correctly.
Measure: Install the stamp correctly. (Refer to page 95.)
- Cause 2: Failure of the stamp mechanism
Measure: Ask the store where purchased.

Print of the stamp is too light.

- Cause 1: Stamp ink is not enough.
Measure: Replenish the ink. (Refer to page 95.)

3. Trouble concerning Keyboard

Key on the keyboard does not function.

- Cause 1: Control Lock is in the OFF position.
Measure: Turn the Control Lock to the positions other than OFF using the Control Key.
- Cause 2: Failure of the keyboard itself
Measure: Ask the store where purchased.

4. Trouble concerning Drawer

Drawer does not open.

- Cause 1: Drawer catches foreign substance (coin, etc.).
Measure: Try to open the drawer by removing the foreign substance, using a ruler or something. If not effective, ask the store where purchased.
- Cause 2: Failure of the drawer itself
Measure: Ask the store where purchased.

5. Trouble concerning Display

Display displays nothing.

- Cause 1: Register is not securely plugged in.
Measure: Securely plug in an outlet.
- Cause 2: Control Lock is in the OFF position.
Measure: Turn the Control Lock to the positions other than OFF using the Control Key.

Some segment is not displayed, display shimmers, or illumination of the display is uneven.

- Cause 1: Failure of the display tube
Measure: Ask the store where purchased.

6. Trouble during Normal Operations

NOTE on changing the Control Lock position:

Changing the Control Lock position during sales entries or programming causes an error. To clear the error, return the Control Lock to the original position. However, changing the Control Lock position to the OFF does not cause an error. Error caused by changing the Control Lock position cannot be cleared by the [C] key.

Normal operations cannot be carried out.

- Cause 1: Control Lock position does not correspond to the operation you attempted.
Measure: Check whether or not the Control Lock position corresponds to the operation.

Error tone beeps

- Cause 1: Operation procedure is incorrect.
Measure: Depress the **[C]** key to clear the error, then check the operation procedure you attempted.
- Cause 2: Control Lock position is incorrect.
Measure: Turn the Control Lock to the correct position using the Control Key.
- Cause 3: Operation in the REG position was attempted while the drawer remained open. (In case that the Drawer-close Compulsory Option has been selected.) (Chapter “**16. System Option Setting**”, **Address 16 - Bit 1** on page 81)
Measure: Close the drawer, then depress the **[C]** key.

7. Trouble in the REG Position

Operations in the REG position cannot be carried out.

- Cause 1: Control Lock is not in the REG position.
Measure: Turn the Control Lock to the REG position using the Control Key.
- Cause 2: Sign-ON was not performed when the Cashier Signing Option has been selected. (Chapter “**16. System Option Setting**”, **Address 2 - Bit 8** on page 72)
Measure: Perform the sign-ON. (Refer to page 82.)
- Cause 3: Operation was attempted while the drawer remained open. (In case that the Drawer-close Compulsory Option has been selected.) (Chapter “**16. System Option Setting**”, **Address 16 - Bit 1** on page 81)
Measure: Close the drawer, then depress the **[C]** key.

8. Trouble in the SET Position

Operations in the SET position cannot be carried out.

- Cause 1: Control Lock is not in the SET position.
Measure: Turn the Control Lock to the SET position using the Control Key.
- Cause 2: Condition for the programming is not satisfied.
Measure: Check the condition for the programming .
- Cause 3: Operation procedure is incorrect.
Measure: Check the operation procedure you attempted.

23. Status Clear and Memory Clear Operations

The operations described in this chapter are provided for initial start-up of the machine or emergency but not to be operated as part of daily routines. Do not perform any of these operations unless it is really necessary.

Status Clear

The operation defined as "Status Clear" will only clear an error or key-locked condition that disables normal operations (though it seldom happens). Thus neither the sales data nor the programmed data will be cleared by a Status Clear (except that when a Status Clear is operated to clear a key-locked condition during a sale, the sale item data already entered for the current sale will be cleared).

The Status Clear also has the function to obtain the condition "after all sales data resets" (as if all sales data had been reset) but will not actually affect any sales data. Such a condition is required in some programming operations and is usually obtained by taking the required reset reports. However, when you do not want the sales data to be reset because it is still in the business hours, etc., this function of the Status Clear will be effective. But be careful in using the function; depending on the programming item, sales data resets may really be necessary instead of a Status Clear, to keep consistency between the programmed data and the sales data.

Operating Procedure

Condition: Any time, outside or during any operation sequence

Operation: Remove the plug of the register's power cord from the wall outlet (to turn OFF the power).

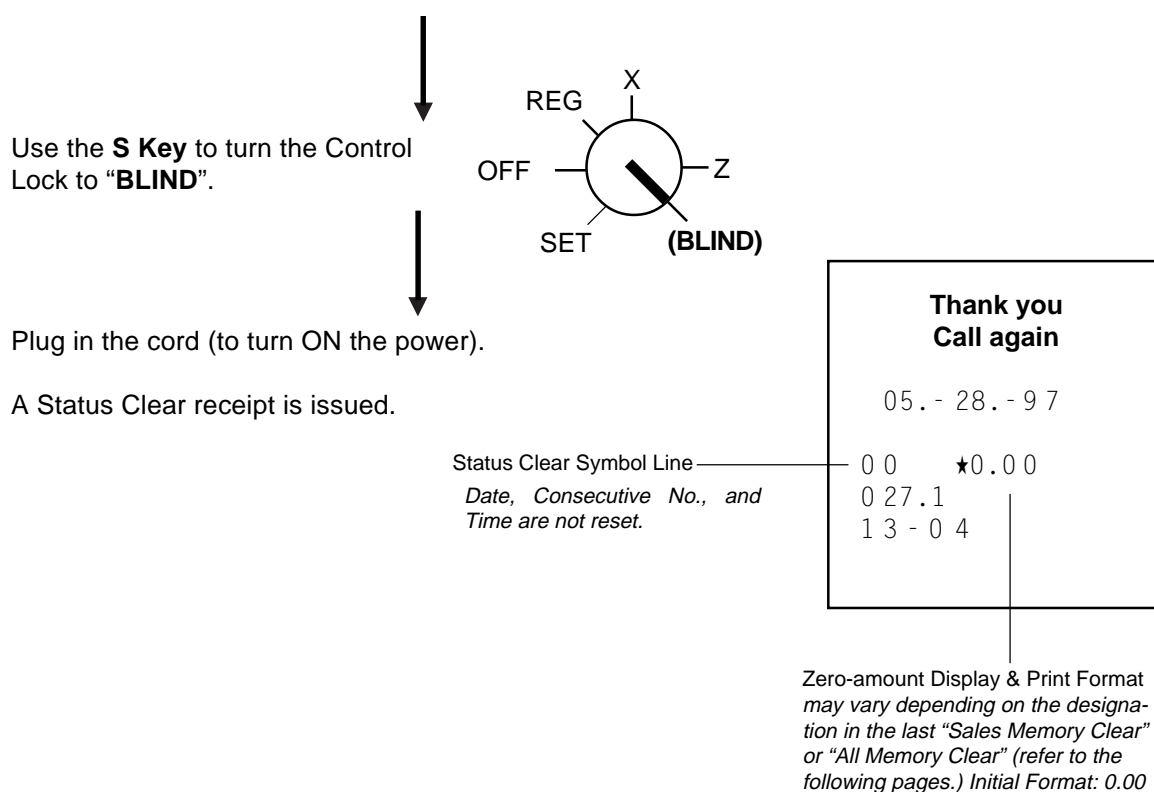

Sales Memory Clear

The operation defined as “Sales Memory Clear” will only clear the sales data accumulated in the register’s memory (report memory). The programmed data will not be cleared. By operating a Sales Memory Clear , all the sales data including non-resettable totals and counters, Reset Report Counts, Receipt Consecutive No., and Electronic Journal memory are cleared.

Warning: This clear operation deletes all sales data stored in the register’s memory.

Operating Procedure

Condition: Any time, outside or during any operation sequence except during Key Setting or Key Location Changing or System Option Setting procedure.

Operation:

Use the **S Key** to turn the Control Lock to “**BLIND**”.

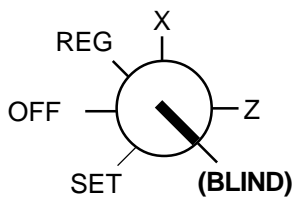

Depress the following Numeric Key according to the display and print format for zero amount:

Numeric Key	Zero-amount Format
1	. 0
3	0 . 0 0

for use in US or Canada

Depress the **AT/TL** key.

A Sales Memory Clear receipt is issued.

Sales Memory Clear Symbol Line (03 for Numeric 3, 01 for Numeric 1) — 0 3 ★0.0 0
 — 0 0 0 . 1
 — 1 3 - 0 4

Receipt Consecutive No. is reset to 0001.
 (Date and Time remain unreset.)

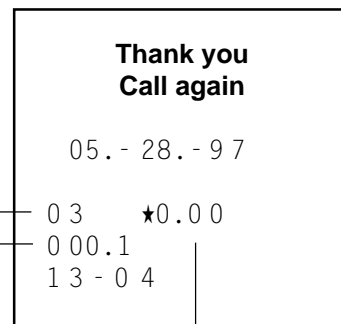

Zero-amount Display & Print Format designated here.

NOTE: When a Sales Memory Clear is operated, the condition “after all sales data reset” is obtained, just as “Status Clear” or “All Memory Clear”. Therefore, no Reset Reports need to be taken for starting any programming operation.

All Memory Clear

If the register becomes completely inoperative due to battery discharge or malfunction of the program memory, the All Memory Clear operation must be carried out. When an All Memory Clear is operated, all the memory contents that have been stored in the RAM will be cleared (i.e., the programmed data and the sales data). Along with the clearing process, the designated zero-amount format is set and "Initial Data" and "Initial Status" for respective programming items are automatically set.

Warning: This clear operation deletes all programmed data and sales data stored in the register's memory. (i.e., the register goes back to initial status.)

Operating Procedure

Condition: Any time, outside or during any operation sequence except during Key Setting or Key Location Changing or System Option Setting procedure.

Operation:

Use the **S Key** to turn the Control Lock to "BLIND".

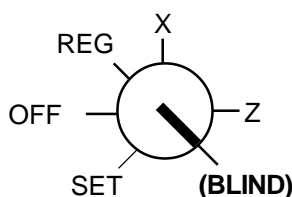

Depress the following Numeric Key according to the display and print format for zero amount and the nation where the register is used:

Numeric Key	Zero-amount Format
1 9	. 0
3 9	0 . 0 0

for use in US or Canada

Depress the **AT/TL** key.

An All Memory Clear receipt is issued.

All Memory Clear Symbol Line
 (39 for Numeric 39, 19 for Numeric 19)

Receipt Consecutive No. is reset to 0001.
 (Date and Time remain unreset.)

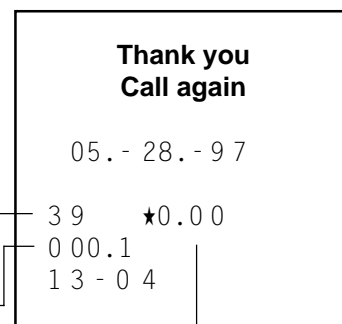

Zero-amount Display & Print Format designated here.

NOTE: When an All Memory Clear is operated, the condition "after all sales data reset" is obtained, just as "Status Clear" or "Sales Memory Clear". Therefore, no Reset Reports need to be taken for starting any programming operation.

24. Specifications

Size ... 460 mm (width) x 453 mm (depth) x 299 mm (height including rubber feet)
(or 355 mm (height) when Customer's Display is popped up)

Weight ... 11.4 kg
Power Required ... AC 117V ± 10 %; 60Hz ± 10 %
Power Consumed ... 0.3A (operating), 0.1A (non-operating)
Ambient Temperature ... 0°C to 40°C
Relative Humidity ... 10% to 90% RH (non-condensing)

Size of Paper Roll

	Ordinary Paper (Single sheet)	Carbonless Duplicating Paper (Double sheet)
Width	57.5 + 0.6/-0.5 mm	57.5 + 0.6/-0.5 mm
Diameter	Max. 80 mm	Max. 80 mm
Recommended Quality and Product	High-quality paper 45 kg	Receipt Sheet: High-quality paper 45 kg Journal Sheet: MITSUBISHI, NCR Paper DIASELF N40 or equivalent Paper Color: White Copy print Color: Blue

Amount and Counter Totals in Report Memory

Report (digits)	Daily				Periodical Report Memory
	Amount (digits)	Item Count Count (digits)	Operation Count (digits)	Customer	
<u>Financial Report Items</u> Grand Total (non-resettable) Other Items NOTE Read and Reset Counters	16 9	5 (+2 decimal)	5 4	5	Provided (except media-in-drawer totals)
<u>Department</u>	9	5 (+2 decimal)		5	Provided
<u>PLU</u> Reset Counter	9	5 (+2 decimal)	4		-----
<u>Cashier</u> Gross Sale Reset Counter	9	5 (+2 decimal)	4	5	Provided
<u>Hourly Range Sale</u> Reset Counter	9		4	5	-----

NOTE: Some items have an Amount and a Counter, some have an Amount only, others have a Counter only.
The counter type varies depending on the item.

Memory Protection

Dry Battery SUM-3 1.5 x 3 pieces; Life of about 1 year.
(Be certain to replace batteries with new ones every year.)

Handling the Batteries

- When inserting batteries, place them so that the positive (+) and negative (-) ends face the proper directions as shown in the battery compartment.
- Do not mix used and new batteries in the battery compartment. Replace all batteries at the same time.
- Do not leave discharged batteries in the battery compartment. Leakage from such batteries may damage the register.
- Do not dispose the batteries in a fire. If put in a fire, they may explode.

Specifications are subject to change without notice.

STAMP ORDER

Dear Customer;

A Receipt Stamp (Electro-stamp) "Thank you Call again" comes with each unit. If you prefer printing your company name or message to Thank you Call again for receipt inprint, please place your order by using the order form below.

Please complete the order form and mail with your check for \$32.50 US Dollar.

Replenishment ink is also available for \$3.50 US Dollar for purple ink.

----- CUT OFF ----- CUT OFF ----- CUT OFF -----

TEC STAMP ORDER FORM		DATE _____															
ORDER TO:	CARDA INTERNATIONAL P.O. Box 2189 Corpus Christi, TX 78403 (800) 354-6416 (Fax) (800) 322-4515 (Voice)																
SOLD TO:	COMPANY NAME _____ ADDRESS _____ CITY _____ COUNTRY _____ YOUR NAME _____ PHONE _____ ZIP CODE _____																
Please show the text of your stamp here (words only).																	
<div style="border: 1px dashed black; height: 100px; width: 100%;"></div>	TOSHIBA TEC MODEL: MA-186-100																
	<table border="1" style="width: 100%; border-collapse: collapse;"> <thead> <tr> <th style="width: 40%;">Description</th> <th style="width: 15%;">UNIT PRICE</th> <th style="width: 10%;">QTY</th> <th style="width: 35%;">AMOUNT</th> </tr> </thead> <tbody> <tr> <td style="text-align: center;">STAMP</td> <td style="text-align: center;">\$32.50</td> <td></td> <td></td> </tr> <tr> <td style="text-align: center;">Replenishment Ink</td> <td style="text-align: center;">\$3.50</td> <td></td> <td></td> </tr> <tr> <td colspan="3" style="text-align: right;">TOTAL</td> <td></td> </tr> </tbody> </table>	Description	UNIT PRICE	QTY	AMOUNT	STAMP	\$32.50			Replenishment Ink	\$3.50			TOTAL			
Description	UNIT PRICE	QTY	AMOUNT														
STAMP	\$32.50																
Replenishment Ink	\$3.50																
TOTAL																	
Please mail your check with the order form. For more detail, please contact Carda International.																	

- NOTES:**
1. If you order two or more design stamps, please make copies of this form.
 2. Carda International is an independent company and is not affiliated with TOSHIBA TEC.
 3. Carda International also accepts orders for custom logos at an additional cost.

For supplies, service or assistance call:

Please have the following information available when you call:

Product Name: TEC Electronic Cash Register
Model: MA-186-100
Serial Number: _____
Place Purchased: _____
Date of Purchase: _____

If for any reason this product is to be returned to the store where purchased, it must be packed in the original carton.



TEC
TEC CORPORATION

 PRINTED IN JAPAN



TEC
TEC CORPORATION